



NSX-AJ20

U

NSX-SZ20

LH,EZ,K,V

NSX-SZ22

EZ

NSX-SZ27

EZ

NSX-DR1

EZ

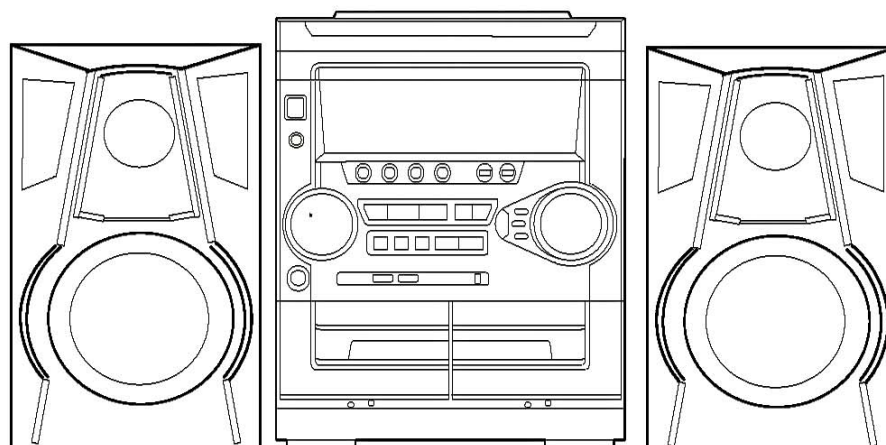

SERVICE MANUAL

COMPACT DISC
STEREO SYSTEM

BASIC TAPE MECHANISM : ZZM-3
BASIC CD MECHANISM : AZG-1

SYSTEM	CD CASSEIVER	TAPE MECHANISM	CD MECHANISM	SPEAKER	REMOTE CONTROLLER
NSX-AJ20<U>	CX-NAJ20	ZZM-3 PR1NF	AZG-1 YKZD3RDF	SX-NAJ22	RC-ZAS02
NSX-SZ20<LH>	CX-NSZ20			SX-NSZ22	
NSX-SZ20 <EZ,K,V>	CX-NSZ20	ZZM-3 PR1NM	AZG-1 ZD3RDM	SX-NSZ20	
NSX-SZ22<EZ>	CX-NSZ22			SX-NSZ22	
NSX-DR1<EZ>	CX-NDR1			SX-NSZ20	
NSX-SZ27<EZ>	CX-NSZ27			SX-NSZ20	

- This Service Manual contains information about the difference between NSX-AJ20/SZ20/SZ22/SZ27/DR1 (VA model) and NSX-AJ20/SZ20/SZ22/SZ27/DR1. If requiring the other information, see Service Manual as listed on page 2.
- Refer to MAIN C.B parts number for difference of model.
8A-NF9-701-010 is for NSX-AJ20<U>/SZ20<LH,EZ,K,V>/SZ22<EZ>/SZ27<EZ>/DR1<EZ> VA model.
- If requiring information about the CD mechanism, see Service Manual of AZG-1 (S/M Code No. 09-001-335-3N8)

aiwa

S/M Code No. 09-00C-423-4S3

SUPPLEMENT
DATA

VA MODEL	BASE MODEL	
	MODEL NAME	S/M Code No.
NSX-AJ20<U> NSX-SZ20<LH>	NSX-AJ20<U> NSX-SZ20<LH>	09-001-423-4R1
NSX-SZ20<EZ,K> NSX-SZ22<EZ> NSX-SZ27<EZ>	NSX-SZ20<EZ,K> NSX-SZ22<EZ> NSX-SZ27<EZ>	09-003-423-4R2
NSX-DR1<EZ> NSX-SZ20<V>	NSX-DR1<EZ> NSX-SZ20<V>	09-007-423-4R4

Precaution to replace Optical block
(KSS-213F)

Body or clothes electrostatic potential could ruin laser diode in the optical block. Be sure ground body and workbench, and use care the clothes do not touch the diode.

- 1) After the connection, remove solder shown in the right figure.

(KSS – 213F)
CD PICK-UP Assy. PWB

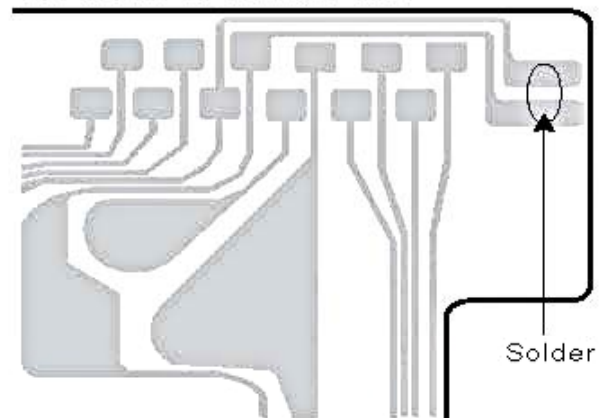

SPECIFICATIONS

<FM tuner section>		<Compact disc player section>	
Tuning range<V>	FM1 (OIRT) 65 MHz to 74 MHz (10 kHz step) FM2 (CCIR) 87.5 MHz to 108 MHz (50 kHz step)	Laser	Semiconductor laser ($\lambda = 780 \text{ nm}$)
Tuning range<Except V>	U, LH: 13.2 dBf	D-A converter	1 bit dual
Usable sensitivity (IHF)	EZ, K: 16.8 dBf V: FM1: 15.3 dBf FM2: 12.8 dBf	Signal-to-noise ratio	85 dB (1 kHz, 0 dB)
Antenna terminals	75 ohms (unbalanced)	Harmonic distortion	0.05 % (1 kHz, 0 dB)
<AM/MW tuner section>		<Speaker system>	
Tuning range	531 kHz to 1602 kHz (9 kHz step) 530 kHz to 1710 kHz (10 kHz step)	<U: SX-NAJ22>	
Usable sensitivity	350 $\mu\text{V/m}$	<LH, 22EZ: SX-NSZ22>	
Antenna	Loop antenna	<20EZ, 20K, 27EZ, DR1, V: SX-NSZ20>	
<LW tuner section><EZ, K>		Speaker System	3 way, bass reflex (magnetic shielded type)
Tuning range	144 kHz to 290 kHz	Speaker units	Woofer: 140 mm ($5\frac{5}{8}$ in.) cone type Tweeter: 60 mm ($2\frac{3}{8}$ in.) cone type Super tweeter: 20 mm ($1\frac{3}{16}$ in.) ceramic type
Usable sensitivity	1400 $\mu\text{V/m}$	Impedance	6 ohms
Antenna	Loop antenna	Output sound pressure level	87 dB/W/m
<Amplifier section>		Dimensions (W x H x D)	230 x 324 x 256 mm (9 $\frac{1}{8}$ x 12 $\frac{7}{8}$ x 10 $\frac{1}{8}$ in.)
Power output	Rated U: 50 W + 50 W (50 Hz - 20 kHz, THD less than 1%, 6 ohms) LH: 40 W + 40 W (1 kHz, THD 1%, 6 ohms) EZ, K, V: 30 W + 30 W (6 ohms, THD 1%, 1 kHz/DIN 45500) Reference U: 62 W + 62 W (1 kHz, THD less than 10%, 6 ohms) LH: 50 W + 50 W (1 kHz, THD 10%, 6 ohms) EZ, K, V: 35 W + 35 W (6 ohms, THD 10%, 1 kHz/DIN 45324) EZ: DIN MUSIC POWER: 67 W + 67 W	Weight	3.8 kg (8 lbs 6 oz.)
Total harmonic distortion	U: 0.08% (25 W, 1 kHz, 6 ohms, DIN AUDIO) LH: 0.05% (25 W, 1 kHz, 6 ohms, DIN AUDIO) EZ, K, V: 0.08% (15 W, 1 kHz, 6 ohms, DIN AUDIO)	<General>	
Inputs	VIDEO/AUX: 500 mV	Power requirements	U: 120 V AC, 60 Hz LH: 120 V/220-230 V/240 V AC (switchable), 50/60 Hz EZ, K, V: 230 V AC, 50 Hz
Outputs	SPEAKERS: accept speakers of 6 ohms or more SURROUND SPEAKERS <U> accept speakers of 6 ohms or more PHONES (stereo jack): accept headphones of 32 ohms or more	Power consumption	U: 75 W LH, EZ, K, V: 80 W
<Cassette deck section>		Power consumption	With power-economizing mode off: U, LH: 13 W EZ, K, V: 14 W With power-economizing mode on: 0.9 W
Track format	4 tracks, 2 channels stereo	Dimensions of main unit (W x H x D)	260 x 328 x 335 mm (10 $\frac{1}{4}$ X 13 X 13 $\frac{1}{4}$ in.)
Frequency response	50 Hz - 15 kHz	Weight of main unit	U: 6.4 kg (14 lbs 2 oz.) LH, K: 6.3 kg EZ, V: 6.2 kg
Recording system	AC bias		
Heads	Deck 1: Playback head x 1 Deck 2: Recording/Playback head x 1, erase head x 1		

• Design and specifications are subject to change without notice.

• The word "BBE" and the "BBE symbol" are trademarks of BBE Sound, Inc.
Under license from BBE Sound, Inc.

ELECTRICAL MAIN PARTS LIST

REF. NO.	PART NO.	KANRI NO.	DESCRIPTION	REF. NO.	PART NO.	KANRI NO.	DESCRIPTION
IC							
	87-070-127-110		IC, LC72131D<EZ, K, V>	C10	87-012-368-080		C-CAP, S 0.1-50 F
	87-A21-928-010		IC, LC72131D-N<U, LH>	C11	87-012-368-080		C-CAP, S 0.1-50 F
	87-A21-401-040		C-IC, M61503FP	C12	87-012-368-080		C-CAP, S 0.1-50 F
	87-A21-482-010		IC, R6M6938-H4<EZ, K, V>	C19	87-A10-627-000		CAP, E 2200-50 SMG
	87-A21-831-010		IC, SPS-442-1-F1<U, LH>	C20	87-A10-627-000		CAP, E 2200-50 SMG
	87-A21-560-010		IC, LA1844L-A	C21	87-016-495-000		CAP, E 3300-25 M SMG<U, LH>
	87-A21-419-040		C-IC, NUM14558MD-TE2	C22	87-016-495-000		CAP, E 3300-25 M SMG<U, LH>
	8A-NF9-604-110		C-IC, UPD780226GF-019-3BA<EXCEPT 22EZ>	C22	87-A10-520-000		CAP, E 3300-35 M SMG<U, LH>
	8A-NF9-606-010		C-IC, UPD780228GF-073-3BA<22EZ>	C25	87-010-384-080		CAP, ELECT 100-25M<U>
	87-A21-269-010		IC, EW732	C25	87-010-385-080		CAP, ELECT 220-25V<LH, EZ, K, V>
	87-A20-440-040		C-IC, BU1920FS<22EZ>	C26	87-010-384-080		CAP, ELECT 100-25M
				C27	87-010-384-080		CAP, ELECT 100-25M<U>
				C27	87-010-385-080		CAP, ELECT 220-25V<LH, EZ, K, V>
				C28	87-010-384-080		CAP, ELECT 100-25M
TRANSISTOR							
	87-026-609-080		TR, KTA1266GR	C30	87-010-430-080		CAP, ELECT 100-63
	89-213-702-010		TR, 2S81370E	C31	87-010-263-080		CAP, ELECT 100-10V
	87-026-610-080		TR, KTC3198GR	C32	87-010-197-080		CAP, CHIP 0.01-25 K B
	87-A30-076-080		C-TR, 2SC3052F	C33	87-010-263-080		CAP, E 100-10 MILL<U>
	87-A30-075-080		C-TR, 2SA1235F	C34	87-010-247-080		CAP, ELECT 100-50V
	87-026-245-080		TR, DTC114ES<LH>	C35	87-010-380-080		CAP, ELECT 47-16 M
	87-A30-198-080		TR, KTC3199GR<LH>	C36	87-010-381-080		CAP, ELECT 330-16V
	87-A30-107-070		C-TR, CMBT5401	C38	87-010-197-080		CAP, CHIP 0.01-25 K B
	87-A30-106-040		C-TR, CMBT5551	C61	87-010-403-080		CAP, ELECT 3.3-50V
	87-A30-091-080		FET, 2S7460		87-010-260-080		CAP, ELECT 47-25V
	87-A30-062-080		C-TR, KRQ104S	C97	87-010-196-080		CHIP CAPACITOR, 0.1-25
	87-A30-090-080		FET, 2SK2541	C99	87-010-196-080		CHIP CAPACITOR, 0.1-25<EZ, K, V>
	87-A30-318-080		TR, CSA952K	C101	87-010-185-080		C-CAP, S 3900P-50 B
	87-A30-329-080		TR, CD1585BC	C102	87-010-185-080		C-CAP, S 3900P-50 B
	87-A30-074-080		C-TR, RT1P 141C	C103	87-010-545-080		CAP, E 0.22-50 M
	87-A30-468-080		C-TR, KRQ102S-RTK	C104	87-010-545-080		CAP, E 0.22-50 M
	87-A30-087-080		C-FET, 2SK2158	C105	87-010-187-080		CAP CHIP S5600P
	87-A30-086-040		C-TR, CSD1306E<EZ, K>	C106	87-010-187-080		CAP CHIP S5600P
	89-503-602-080		C-FET, 2SK360E<EZ, K>	C107	87-010-404-080		CAP, ELECT 4.7-50V
	87-A30-234-080		TR, CSC4115BC	C108	87-010-404-080		CAP, ELECT 4.7-50V
	89-327-143-080		C-TR, 2SC2714 (O)	C109	87-010-322-080		C-CAP, S 100P-50 J CH<EZ, K>
	87-A30-072-080		C-TR, RT1P 144C	C110	87-010-322-080		C-CAP, S 100P-50 J CH<EZ, K>
	87-A30-492-080		TR, 2SC5343G	C111	87-010-391-080		CAP, E 10-35 SME
	87-A30-495-080		TR, 2SA1981Y	C112	87-010-391-080		CAP, E 10-35 SME
	87-A30-427-040		C-TR, DTC114EKA	C113	87-A10-946-080		C-CAP, S 220P-100 J CH
	87-A30-190-080		TR, CC5551	C114	87-A10-946-080		C-CAP, S 220P-100 J CH
	87-A30-528-010		TR, 2S81686	C119	87-010-197-080		C-CAP, S 0.01-25
	87-A30-529-010		TR, 2SD2642	C120	87-010-197-080		C-CAP, S 0.01-25
	87-A30-162-010		FET, 2SK2937	C123	87-010-176-080		C-CAP, S 680P-50 J SL<EZ, K, V>
				C124	87-010-176-080		C-CAP, S 680P-50 J SL<EZ, K, V>
DIODE							
	87-A40-553-080		DIODE, 1N4003 LES	C125	87-012-368-080		C-CAP, S 0.1-50 F
	87-A40-776-080		ZENER, UZ27BSD	C126	87-012-368-080		C-CAP, S 0.1-50 F
	87-A40-764-080		ZENER, UZ10BSC	C127	87-012-368-080		C-CAP, S 0.1-50 F
	87-A40-313-080		C-DIODE, MC 2840	C128	87-012-368-080		C-CAP, S 0.1-50 F
	87-A40-270-080		C-DIODE, MC2838	C129	87-010-191-080		C-CAP, S 0.015-50 F
	87-A40-269-080		C-DIODE, MC2836	C130	87-010-191-080		C-CAP, S 0.015-50 F
	87-A40-752-080		ZENER, UZ6.2BSC	C131	87-010-197-080		CAP, CHIP 0.01-25 K B
	87-A40-739-080		ZENER, UZ2.7BSA	C132	87-010-197-080		CAP, CHIP 0.01-25 K B
	87-020-465-080		DIODE, 1SS133	C133	87-010-186-080		CAP, CHIP 4700P-50 K
	87-A40-854-080		ZENER, UZ15BSA	C140	87-010-182-080		C-CAP, S 2200P-50 B
	87-A40-535-080		DIODE, 1N5393-GOODARK<LH>	C141	87-010-196-080		CHIP CAPACITOR, 0.1-25
	87-017-149-080		ZENER, HZ56A2L	C186	87-010-196-080		CHIP CAPACITOR, 0.1-25
	87-A40-393-090		DIODE, 1N5402GM (F20)	C187	87-010-405-080		CAP, ELECT 10-50V
	87-A40-749-080		ZENER, UZ5.6BSB	C188	87-010-405-080		CAP, ELECT 10-50V
	87-A40-455-080		DIODE, RL203 GM<U>	C235	87-010-408-080		CAP, ELECT 47-50V<U>
				C236	87-010-408-080		CAP, ELECT 47-50V<U>
				C239	87-010-196-080		CHIP CAPACITOR, 0.1-25
				C301	87-010-178-080		C-CAP, S 1000-50 K B
				C302	87-010-178-080		C-CAP, S 1000-50 K B
				C303	87-010-178-080		C-CAP, S 1000-50 K B
MAIN C.B							
	87-012-368-080		C-CAP, S 0.1-50 F	C304	87-010-178-080		C-CAP, S 1000-50 K B
	87-012-368-080		C-CAP, S 0.1-50 F	C307	87-010-263-080		CAP, ELECT 100-10V
	87-012-368-080		C-CAP, S 0.1-50 F	C308	87-010-263-080		CAP, ELECT 100-10V
	87-012-368-080		C-CAP, S 0.1-50 F	C309	87-010-318-080		C-CAP, S 47P-50 CH
	87-012-368-080		C-CAP, S 0.1-50 F	C310	87-010-318-080		C-CAP, S 47P-50 CH

REF. NO.	PART NO.	KANRI NO.	DESCRIPTION	REF. NO.	PART NO.	KANRI NO.	DESCRIPTION
C313	87-010-188-080		CAP, CHIP 6800P	C792	87-010-197-080		CAP, CHIP 0.01-25 K B
C314	87-010-188-080		CAP, CHIP 6800P	C793	87-010-404-080		CAP, ELECT 4.7-50V
C315	87-010-263-080		CAP, ELECT 100-10V	C794	87-012-140-080		C-CAP, S 470P-50 J<EXCEPT U, LH, 22EZ>
C317	87-010-546-080		CAP, ELECT 0.33-50V	C794	87-012-155-080		C-CAP, S 180P-50 J<22EZ>
C318	87-010-546-080		CAP, ELECT 0.33-50V	C795	87-010-197-080		CAP, CHIP 0.01-25 K B
C326	87-010-198-080		CAP, CHIP 0.022-25 K	C796	87-010-197-080		CAP, CHIP 0.01-25 K B
C327	87-012-368-080		C-CAP, S 0.1-50 F	C797	87-010-405-080		CAP, ELECT 10-50V
C360	87-010-401-080		CAP, ELECT 1-50V	C798	87-010-197-080		CAP, CHIP 0.01-25 K B
C399	87-012-140-080		C-CAP, S 470P-50 J	C799	87-010-407-080		CAP, ELECT 33-50V
C401	87-010-544-080		CAP, ELECT 0.1-50V	C800	87-012-369-080		C-CAP, S 0.047-50F
C402	87-010-544-080		CAP, ELECT 0.1-50V	C801	87-010-403-080		CAP, ELECT 3.3-50V
C403	87-010-321-080		CHIP CAPACITOR, 82P (J)	C802	87-010-194-080		CAP, CHIP 0.047-25 Z F
C404	87-010-321-080		CHIP CAPACITOR, 82P (J)	C803	87-010-198-080		CAP, CHIP 0.022-25 K B
C405	87-010-197-080		CAP, CHIP 0.01-25 K B	C804	87-010-263-080		CAP, ELECT 100-10V
C406	87-010-197-080		CAP, CHIP 0.01-25 K B	C807	87-010-400-080		CAP, ELECT 0.47-50V
C407	87-010-197-080		CAP, CHIP 0.01-25 K B	C808	87-010-401-080		CAP, ELECT 1-50V
C408	87-010-197-080		CAP, CHIP 0.01-25 K B	C809	87-010-401-080		CAP, ELECT 1-50V
C409	87-010-182-080		C-CAP, S 2200P-50 B	C810	87-010-196-080		CHIP CAPACITOR, 0.1-25
C410	87-010-182-080		C-CAP, S 2200P-50 B	C814	87-010-197-080		CAP, CHIP 0.01-25 K B
C411	87-010-405-080		CAP, ELECT 10-50V	C815	87-010-400-080		CAP, ELECT 0.47-50V
C412	87-010-405-080		CAP, ELECT 10-50V	C816	87-010-400-080		CAP, ELECT 0.47-50V
C452	87-010-382-080		CAP, ELECT 22-25V	C818	87-010-180-080		C-CAP, S 1500P-50 KB<EZ, K>
C453	87-010-183-080		C-CAP, S 2700P-50 B	C821	87-010-405-080		CAP, ELECT 10-50V
C454	87-010-183-080		C-CAP, S 2700P-50 B	C822	87-010-177-080		C-CAP, S 820P-50 SL
C455	87-010-183-080		C-CAP, S 2700P-50 B	C824	87-010-404-080		CAP, ELECT 4.7-50 M
C456	87-010-197-080		CAP, CHIP 0.01-25 K B	C825	87-010-596-080		CAP, S 0.047-16
C457	87-A12-361-080		CAP, M 5600P-100 J CP	C831	87-010-406-080		CAP, ELECT 22-50<EZ, K>
C458	87-010-178-080		C-CAP, S 1000P-50 K B<EZ, K, V>	C842	87-010-197-080		CAP, CHIP 0.01-25 K B
C459	87-010-175-080		C-CAP, S 560P-50 J SL<EZ, K, V>	C844	87-010-197-080		CAP, CHIP 0.01-25 K B
C460	87-010-196-080		CHIP CAPACITOR, 0.1-25	C850	87-010-260-080		CAP, ELECT 47-25V
C461	87-012-158-080		C-CAP, S 390P-50 CH	C851	87-010-197-080		CAP, CHIP 0.01-25 K B
C470	87-018-127-080		C-CAP, S 390P-50 CH	C852	87-010-197-080		CAP, CHIP 0.01-25 K B
C605	87-010-184-080		CAP, GER 470P-50V	C853	87-010-197-080		CAP, CHIP 0.01-25 K B
C606	87-010-179-080		CAP, CHIP S 3300P-50 KB<U>	C858	87-010-196-080		CHIP CAPACITOR, 0.1-25
C609	87-010-213-080		C-CAP, S 0.015-50 B	C859	87-010-196-080		CHIP CAPACITOR, 0.1-25
C610	87-010-213-080		C-CAP, S 0.015-50 B	C872	87-012-156-010		C-CAP, S 2200P-50 J CH<22EZ>
C611	87-010-545-080		CAP, ELECT 0.22-50V	C873	87-012-140-080		C-CAP, S 470P-50 J CH<22EZ>
C612	87-010-545-080		CAP, ELECT 0.22-50V	C874	87-010-405-080		CAP, ELECT 10-50V<22EZ>
C613	87-010-545-080		CAP, ELECT 0.22-50V	C875	87-010-196-080		C-CAP, S 0.1-25 Z F<22EZ>
C614	87-010-154-080		CAP, CHIP 10P-50 CH	C876	87-010-405-080		CAP, ELECT 10-50V<22EZ>
C615	87-010-154-080		CAP, CHIP 10P-50 CH	C877	87-010-197-080		CAP, CHIP 0.01-25 K B<22EZ>
C616	87-010-221-080		CAP, ELECT 470-10 M	C878	87-010-316-080		C-CAP, S 33P-50 J CH GRM<22EZ>
C617	87-010-221-080		CAP, ELECT 470-10 M	C879	87-010-314-080		C-CAP, S 22P-50 J CH GRM<22EZ>
C618	87-010-405-080		CAP, ELECT 10-50V	C890	87-010-197-080		CAP, CHIP 0.01-25 K B<EZ, K>
C630	87-016-669-080		C-CAP, S 0.1-25 K B	C942	87-010-149-080		C-CAP, S 5P-50 CH<EZ, K>
C631	87-010-185-080		C-CAP, S 3900P-50 B	C947	87-010-197-080		CAP, CHIP 0.01-25 K B<EZ, K>
C632	87-010-185-080		C-CAP, S 3900P-50 B	C948	87-012-140-080		C-CAP, S 470P-50 J CH<EZ, K>
C633	87-016-369-080		C-CAP, S 0.033-25 K B	C952	87-010-197-080		CAP, CHIP 0.01-25 K B
C634	87-016-369-080		C-CAP, S 0.033-25 K B	C957	87-010-311-080		C-CAP, S 12P-50 J CH<EZ, K>
C669	87-010-322-080		C-CAP, S 100P-50 CH	C958	87-010-197-080		CAP, CHIP 0.01-25 K B<EZ, K>
C670	87-010-322-080		C-CAP, S 100P-50 CH	C959	87-010-196-080		CHIP CAPACITOR, 0.1-25
C677	87-010-197-080		CAP, CHIP 0.01-25 K B	C960	87-010-196-080		CHIP CAPACITOR, 0.1-25
C771	87-010-263-080		CAP, ELECT 100-10V	C961	87-010-152-080		C-CAP, S 8P-50 CH<U, LH, V>
C772	87-010-197-080		CAP, CHIP 0.01-25 K B	C962	87-010-401-080		CAP, ELECT 1-50V<EZ, K>
C779	87-010-949-080		C-CAP, S 0.01-50 J B<EZ, K>	C963	87-015-785-080		CHIP CAPACITOR, 0.1FZ-25Z
C780	87-010-949-080		C-CAP, S 0.01-50 J B<EZ, K>	C971	87-010-381-080		CAP, ELECT 330-16V
C782	87-010-197-080		CAP, CHIP 0.01-25 K B	C972	87-010-404-080		CAP, ELECT 4.7-50V
C783	87-010-197-080		CAP, CHIP 0.01-25 K B	C973	87-010-197-080		CAP, CHIP 0.01-25 K B
C784	87-010-197-080		CAP, CHIP 0.01-25 K B	C974	87-010-197-080		CAP, CHIP 0.01-25 K B
C785	87-010-197-080		CAP, CHIP 0.01-25 K B	C979	87-010-322-080		C-CAP, S 100P-50 CH
C786	87-010-197-080		CAP, CHIP 0.01-25 K B	C981	87-010-260-080		CAP, ELECT 47-25V
C788	87-010-149-080		C-CAP, S 5P-50 CH	C982	87-010-196-080		CHIP CAPACITOR, 0.1-25
C789	87-A12-052-080		C-CAP, S 0.033-25 J B<U, LH>	C983	87-010-197-080		CAP, CHIP 0.01-25 K B
C789	87-A10-801-080		C-CAP, S 0.022-16 J B<EZ, K, V>	C984	87-010-197-080		CAP, CHIP 0.01-25 K B
C790	87-A12-052-080		C-CAP, S 0.033-25 J B<U, LH>	C985	87-010-322-080		C-CAP, S 100P-50 CH<EZ, K>
C790	87-A10-801-080		C-CAP, S 0.022-16 J B<EZ, K, V>	C987	87-010-197-080		CAP, CHIP 0.01-25 K B<EZ, K, V>
C791	87-010-196-080		CHIP CAPACITOR, 0.1-25				

REF. NO.	PART NO.	KANRI NO.	DESCRIPTION	REF. NO.	PART NO.	KANRI NO.	DESCRIPTION
C989	87-010-197-080		CAP, CHIP 0.01-25 K B<EZ, K>	C103	87-010-498-040		CAP, E 10-16 M 5L
C991	87-010-312-080		C-CAP, S 15P-50 CH	C104	87-010-196-080		CHIP CAPACITOR, 0.1-25
C992	87-010-312-080		C-CAP, S 15P-50 CH	C107	87-010-493-040		CAP, E 0.47-50 M 5L
C993	87-010-178-080		CHIP CAP 1000P-50 K B	C108	87-012-393-080		C-CAP, S 0.22-16 R K
C995	87-010-178-080		CHIP CAP 1000P-50 K B	C153	87-010-198-080		CAP, CHIP 0.022-25 K B
C997	87-010-196-080		CHIP CAPACITOR, 0.1-25	C154	87-010-246-040		CAP, E 47-35 SME
C998	87-010-260-080		CAP, ELECT 47-25V	C155	87-010-404-040		CAP, E 4.7-50 SME
C999	87-A11-155-080		CAP, TC U 0.01-16 Z F	C156	87-010-404-040		CAP, E 4.7-50 SME
CF831	87-008-261-010		FILTER, SFE10.7MA5-A<U, LH, V>	C361	87-010-178-080		CHIP CAP 1000P-50 K B
CF832	87-008-261-010		FILTER, SFE10.7MA5-A<U, LH, V>	C362	87-010-178-080		CHIP CAP 1000P-50 K B
CF833	82-785-747-010		FILTER, SFE10.7MA5-A<U, LH, V>	C371	87-010-178-080		CHIP CAP 1000P-50 K B
CN301	87-A60-620-010		CF MS2 GHY R<EZ, K>	C372	87-010-178-080		CHIP CAP 1000P-50 K B
CN351	87-A60-625-010		CONN, 3P V 2MM JMT	C601	87-010-382-040		CAP, E 22-25 SME
CN601	87-099-719-010		CONN, 8P V 2MM JMT	C801	87-010-195-080		C-CAP, S 0.068-25 F
CN602	87-A60-131-010		CONN, 30P TYK-B (X)	C802	87-010-195-080		C-CAP, S 0.068-25 F
CN61	8A-NF8-653-010		CONN, 6P V FE	C803	87-010-402-040		CAP, E 2.2-50 SME
CN351	8A-NF8-653-010		CONN ASSY, 9P TID-A(480) <LH>	C804	87-010-402-040		CAP, E 2.2-50 SME
FC602	88-906-251-110		CON ASSY, 8P-PB	C805	87-010-196-080		CHIP CAPACITOR, 0.1-25
FFE831	88-82A-195-030		FF-CABLE, 6P 1.25	C806	87-010-196-080		CHIP CAPACITOR, 0.1-25
FFE831	88-82A-195-030		82A-1 YFEMUNM<U, LH>	C810	87-010-379-040		CAP, E 22-16 M 11L SME
FFE831	A8-62A-19H-030		62A-1 FEMUNM<EZ, K>	C901	87-010-322-080		C-CAP, S 100P-50 CH
FFE831	A8-62A-19K-030		62A-1 FEMUNM<V>	C902	87-010-322-080		C-CAP, S 100P-50 CH
J202	87-A60-488-010		JACK, DIA. 3 BLK ST W/SW KMLGAT	C903	87-010-322-080		C-CAP, S 100P-50 CH
J203	87-A60-238-010		TERMINAL, SP 4P (MSC)	C904	87-010-322-080		C-CAP, S 100P-50 CH
J205	87-A60-881-010		JACK, PIN 2P MSP 242V05 PBSN<U>	C905	87-010-322-080		C-CAP, S 100P-50 CH
J602	87-A60-881-010		JACK, PIN 2P MSP 242V05 PBSN	C906	87-010-322-080		C-CAP, S 100P-50 CH
J831	87-A60-202-010		TERMINAL, ANT 4P MSP-154V-02<U, LH, V>	C907	87-010-322-080		C-CAP, S 100P-50 CH
J832	87-A60-403-010		TERMINAL, ANT PAL 2P HSP312V05<EZ, K>	C908	87-010-322-080		C-CAP, S 100P-50 CH
L101	87-A50-610-010		COIL, 1UH K (MDEC)	C909	87-010-322-080		C-CAP, S 100P-50 CH
L102	87-A50-610-010		COIL, 1UH K (MDEC)	C910	87-010-322-080		C-CAP, S 100P-50 CH
L451	87-007-342-010		COIL, OSC 85K BIAS	C911	87-010-178-080		CHIP CAP 1000P-50 K B
L801	87-A50-608-010		COIL, FM DET-N(TOK)	C912	87-010-196-080		CHIP CAPACITOR, 0.1-25
L802	87-A91-551-010		FLTR, PCFTH-450 L (TOK)	C913	87-010-248-040		CAP, E 220-10 SME
L811	87-005-847-080		COIL, 2.2UH (CECS)	C914	87-010-248-040		CAP, E 220-10 SME
L832	87-005-847-080		COIL, 2.2UH (CECS)	C915	87-010-196-080		CHIP CAPACITOR, 0.1-25
L861	87-005-847-080		COIL, 2.2UH (CECS) <22EZ>	C916	87-010-196-080		CHIP CAPACITOR, 0.1-25
L941	87-A50-020-010		COIL, ANT LM(COI) <EZ, K>	C917	87-010-196-080		CHIP CAPACITOR, 0.1-25
L942	87-A50-019-010		COIL, OSC LM(COI) <EZ, K>	C919	87-010-197-080		CAP, CHIP 0.01-25 K B
L951	8A-NF8-667-010		COIL, AM PRC 4 (TOK) <U, LH, V>	C920	87-012-369-080		C-CAP, S 0.047-50F
L951	8A-NF8-668-010		COIL, AM PRC 2 (TOK) <EZ, K>	C921	87-010-186-080		CAP, CHIP 4700P-50 K B
R129	87-A00-257-080		RES, M/F 0.15-1M J<U, LH>	C951	87-010-312-080		C-CAP, S 15P-50 CH
R130	87-A00-257-080		RES, M/F 0.15-1M J<U, LH>	C952	87-012-155-080		C-CAP 180P-50CH
R131	87-A00-257-080		RES, M/F 0.15-1M J<U, LH>	C953	87-012-140-080		CAP 470P-50 CH
R131	87-A00-258-080		RES, M/F 0.22-1M J RA<EZ, K, V>	C961	87-010-378-040		CAP, E 10-16 M SME
R132	87-A00-257-080		RES, M/F 0.15-1M J<U, LH>	C962	87-012-157-080		C-CAP, S 330P-50 CH
R132	87-A00-258-080		RES, M/F 0.22-1M J RA<EZ, K, V>	C963	87-010-196-080		CHIP CAPACITOR, 0.1-25
R143	87-A00-440-050		RES, 220-1/2W J RP	CN104	87-A60-057-010		CONN, 11P V 9604S-11C
R144	87-A00-440-050		RES, 220-1/2W J RP	CN104	87-099-720-010		CONN, 30P BLK TYK-B(P)
R145	87-A00-440-050		RES, 220-1/2W J RP	CN731	87-099-015-010		CONN, 13P V BLK 6216V
R146	87-A00-440-050		RES, 220-1/2W J RP	FC104	88-911-101-110		FF-CABLE, 11P 1.25
R653	87-A11-144-080		CAP, TC U 0.1-50 K B	FC731	88-913-301-110		FF-CABLE, 13P-1.25
R654	87-A11-144-080		CAP, TC U 0.1-50 K B	FL901	8A-NF9-605-010		FL, HNA-10S12
R790	87-010-197-080		CAP, CHIP 0.01 DM	L951	87-A50-434-010		COIL, CLK 4.19M(TOKO)
R991	87-010-322-080		C-CAP, S 100P-50 CH	LED201	87-A40-619-040		LED, SLR-56PT-T31-W GRN
R993	87-010-322-080		C-CAP, S 100P-50 CH	LED202	87-A40-619-040		LED, SLR-56PT-T31-W GRN
R995	87-010-322-080		C-CAP, S 100P-50 CH	LED204	87-A40-619-040		LED, SLR-56PT-T31-W GRN
SFR451	87-A90-433-080		SFR, 50K H NVZ6TLTA	LED205	87-A40-619-040		LED, SLR-56PT-T31-W GRN
SFR452	87-A90-433-080		SFR, 50K H NVZ6TLTA	LED209	87-A40-317-080		LED, SLR-342VCT31 RED
TC942	87-A91-774-080		TRIMMER, PLY 30P6.8X5.4 CDYL<EZ, K>	LED210	87-A40-619-040		LED, SLR-56PT-T31-W GRN
TH101	87-A91-042-080		C-THMS, 100K 55001	S301	87-A90-164-080		SM, TACT SKQNB(N)
TH102	87-A91-042-080		C-THMS, 100K 55001	S302	87-A90-164-080		SM, TACT SKQNB(N)
WH1	87-A90-510-010		HLDR, WIRE 2.5-9P	S303	87-A90-164-080		SM, TACT SKQNB(N)
W99	8A-NF9-609-010		F-CABLE, 9P 2.5 260MM<EXCEPT LH>	S304	87-A90-164-080		SM, TACT SKQNB(N)
X861	87-A70-091-010		VIB, XTAL 4.332MHZ CSA-309<22EZ>	S305	87-A90-164-080		SM, TACT SKQNB(N)
X991	87-A70-061-010		VIB, XTAL 4.500MHZ CSA-309	S306	87-A90-164-080		SM, TACT SKQNB(N)
FRONT C.B							
C101	87-010-196-080		CHIP CAPACITOR, 0.1-25	S307	87-A90-164-080		SM, TACT SKQNB(N)
C102	87-010-196-080		CHIP CAPACITOR, 0.1-25	S308	87-A90-164-080		SM, TACT SKQNB(N)
				S309	87-A90-164-080		SM, TACT SKQNB(N)
				S321	87-A90-164-080		SM, TACT SKQNB(N)
				S322	87-A90-164-080		SM, TACT SKQNB(N)

REF. NO.	PART NO.	KANRI NO.	DESCRIPTION
S323	87-A90-164-080		SM, TACT SKONAB (N)
S324	87-A90-164-080		SM, TACT SKONAB (N)
S325	87-A90-164-080		SM, TACT SKONAB (N)
S326	87-A90-164-080		SM, TACT SKONAB (N)
S327	87-A90-164-080		SM, TACT SKONAB (N) <22EZ>
S328	87-A90-164-080		SM, TACT SKONAB (N) <22EZ>
S329	87-A90-164-080		SM, TACT SKONAB (N) <22EZ>
S341	87-A90-164-080		SM, TACT SKONAB (N)
S342	87-A90-164-080		SM, TACT SKONAB (N)
S343	87-A90-164-080		SM, TACT SKONAB (N)
S344	87-A90-164-080		SM, TACT SKONAB (N)
S345	87-A90-164-080		SM, TACT SKONAB (N)
S346	87-A90-164-080		SM, TACT SKONAB (N)
S347	87-A90-164-080		SM, TACT SKONAB (N)
S348	87-A90-164-080		SM, TACT SKONAB (N)
S349	87-A90-164-080		SM, TACT SKONAB (N)
S350	87-A90-164-080		SM, TACT SKONAB (N)
S361	87-A91-633-010		SM, PTRY XRE012103PVB25FINA 1-2
S371	87-A91-632-010		SM, PTRY XRE012103PVB25FINB 1-2

PT C.B

C1	87-010-387-080		CAP, E 470-25 SME<LH>
C31	87-010-403-080		CAP, ELECT 3.3-50V<LH>
C183	87-010-387-080		CAP, ELECT 470-25 M<EXCEPT LH>
C184	87-010-403-080		CAP, ELECT 3.3-50 M<EXCEPT LH>
C185	87-A11-148-080		CAP, TC U 0.1-50 Z F<EZ, K, V>
CN1	87-A61-110-010		CONN, 9P V TID-A<LH>
PT1	8A-NF9-710-010		PT, ANF-9U VA<U>
PT1	8A-NF9-713-010		PT, ANF-9EZEK VA<EZ, K, V>
PT1	8A-NF9-711-010		PT, ANF-9H-LOW VA<LH>
PT2	8A-NF8-673-010		PT, SUB ANF-8 (H) KAMI<LH>
PT181	8A-NF8-661-010		PT, SUB ANF-8 (U) <U>
PT181	8A-NF8-662-010		PT, SUB ANF-8 (E) <EZ, K, V>
RY1	87-A91-339-010		RELAY, AC DC12V G5PA-2<LH>
RY181	87-A91-418-010		RELAY, AC12V G5PA-1-M<U, EZ, K, V>
S1	87-A90-165-010		SM, SL 1-2-3 SMS2301<LH>
T1	87-A60-317-010		TERMINAL, 1P MSC<LH>
T2	87-A60-317-010		TERMINAL, 1P MSC<LH>
T181	87-A60-317-010		TERMINAL, 1P MSC<U, EZ, K, V>
T182	87-A60-317-010		TERMINAL, 1P MSC<U, EZ, K, V>
WH181	87-A90-510-010		HDR, WIRE 2.5-9P<U, EZ, K, V>

チップ抵抗部品コード／CHIP RESISTOR PART CODE

チップ抵抗部品コードの成り立ち
Chip Resistor Part Coding

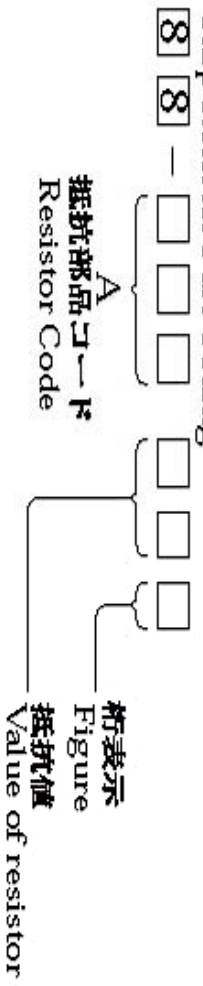

種類 Wattage	種類 Type	許容誤差 Tolerance	記号 Symbol	寸法／Dimensions (mm)			抵抗コード Resistor Code : A
				L	W	t	
1/16W	1005	±5%	CJ	1.0	0.5	0.35	104
1/16W	1608	±5%	CJ	1.6	0.8	0.45	108
1/10W	2125	±5%	CJ	2	1.25	0.45	118
1/8W	3216	±5%	CJ	3.2	1.6	0.55	128

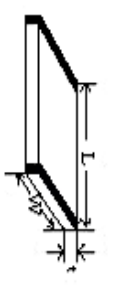

TRANSISTOR ILLUSTRATION



E C B

CD1585BC
CSA952K
KTA1266GR
KTC3198GR
KTC3199GR



E C B

2SC5343G
CC5551



E B C

2SA1981Y



E C B

CSC4115BC

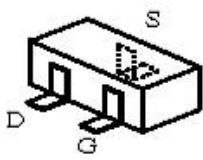

2SK360E

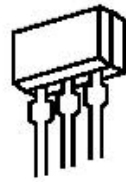

S D G

2SJ460
2SK2541

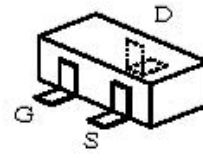

2SK2158

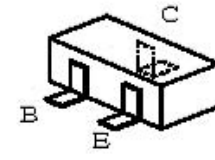

2SA1235F	DTC114EKA
2SC2714(O)	DTC114ES
2SC3052F	KRC102S-RTK
CMBT5401	KRC104S
CMBT5551	RT1P141C
CSD1306E	RT1P144C



B C E

2SB1370E
2SB1686
2SD2642



G D S

2SK2937

A MAIN C.B <U, LH, V>

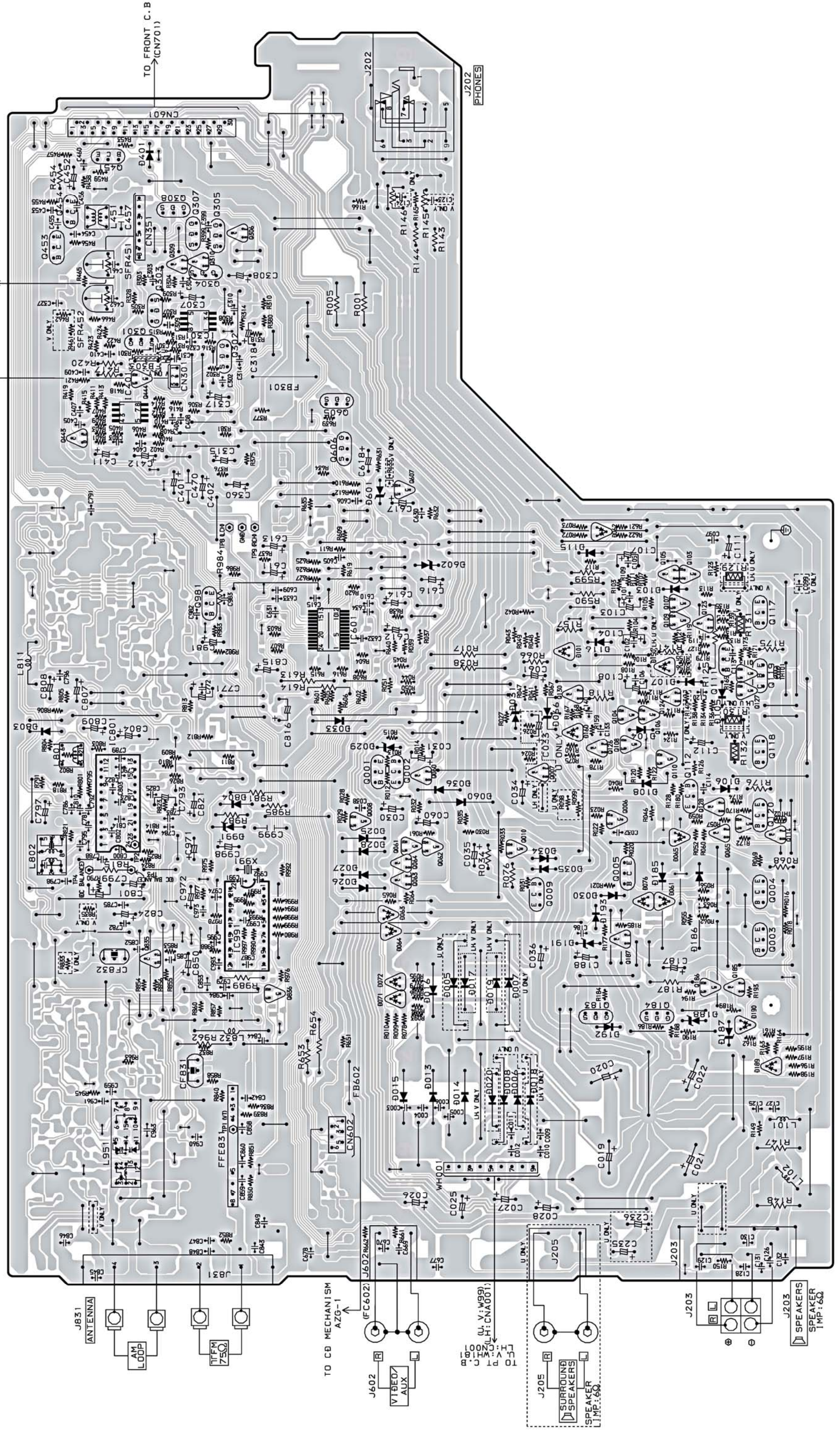

32 31 30 29 28 27 26 25 24 23 22 21 20 19 18 17 16 15 14 13 12 11 10 9 8 7 6 5 4 3 2 1

A B C D E F G H I J K L M N O P Q R S T U

A MAIN C.B. <EZ, K>

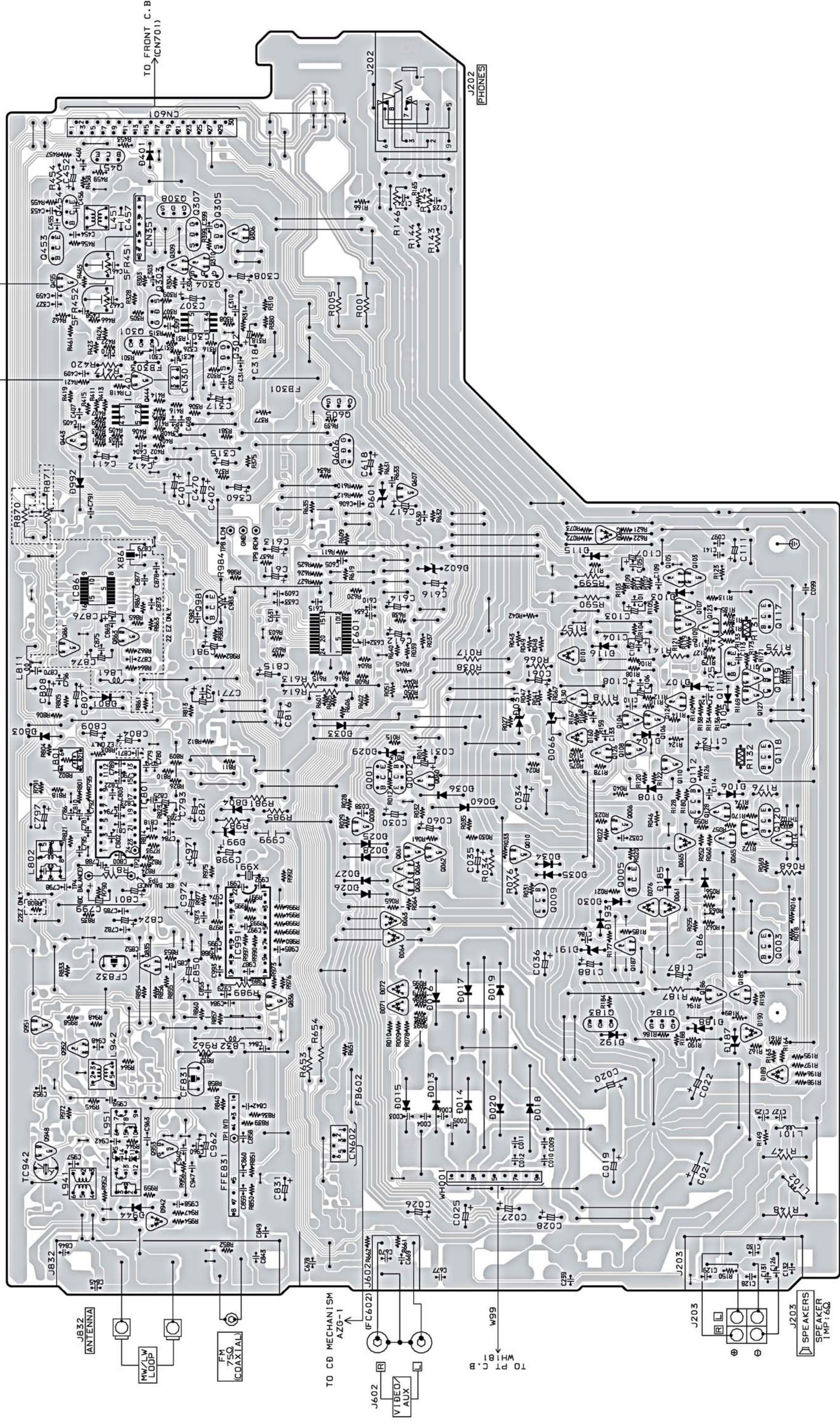

SCHEMATIC DIAGRAM - 1 (MAIN 1/2:AMP)

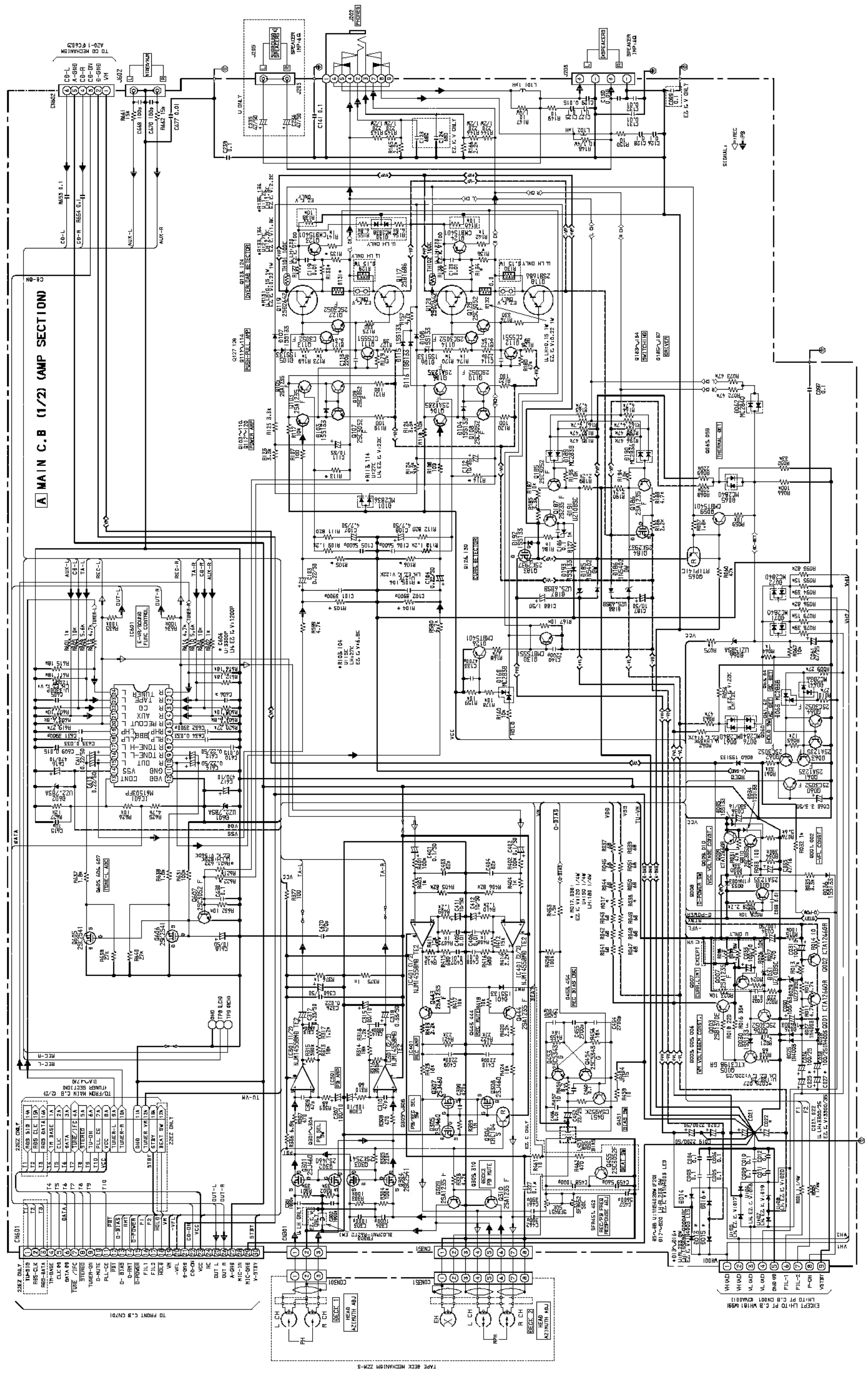

SCHEMATIC DIAGRAM - 2 (MAIN 2/2: TUNER) <U,LH>

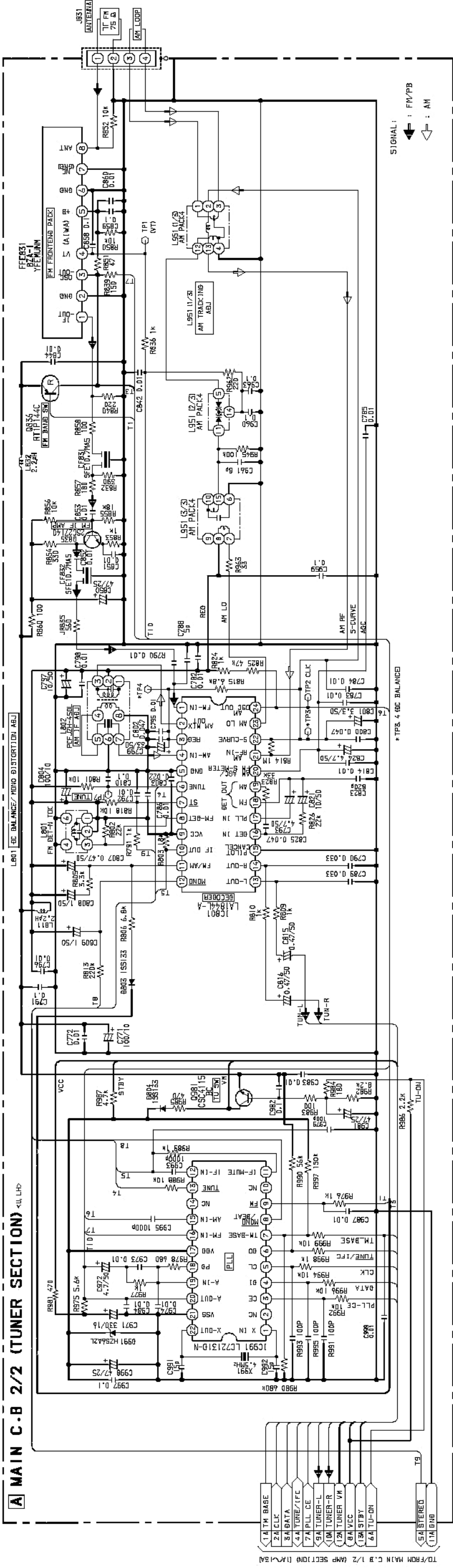

SCHEMATIC DIAGRAM - 3 (MAIN 2/2 : TUNER) <EZ,K>

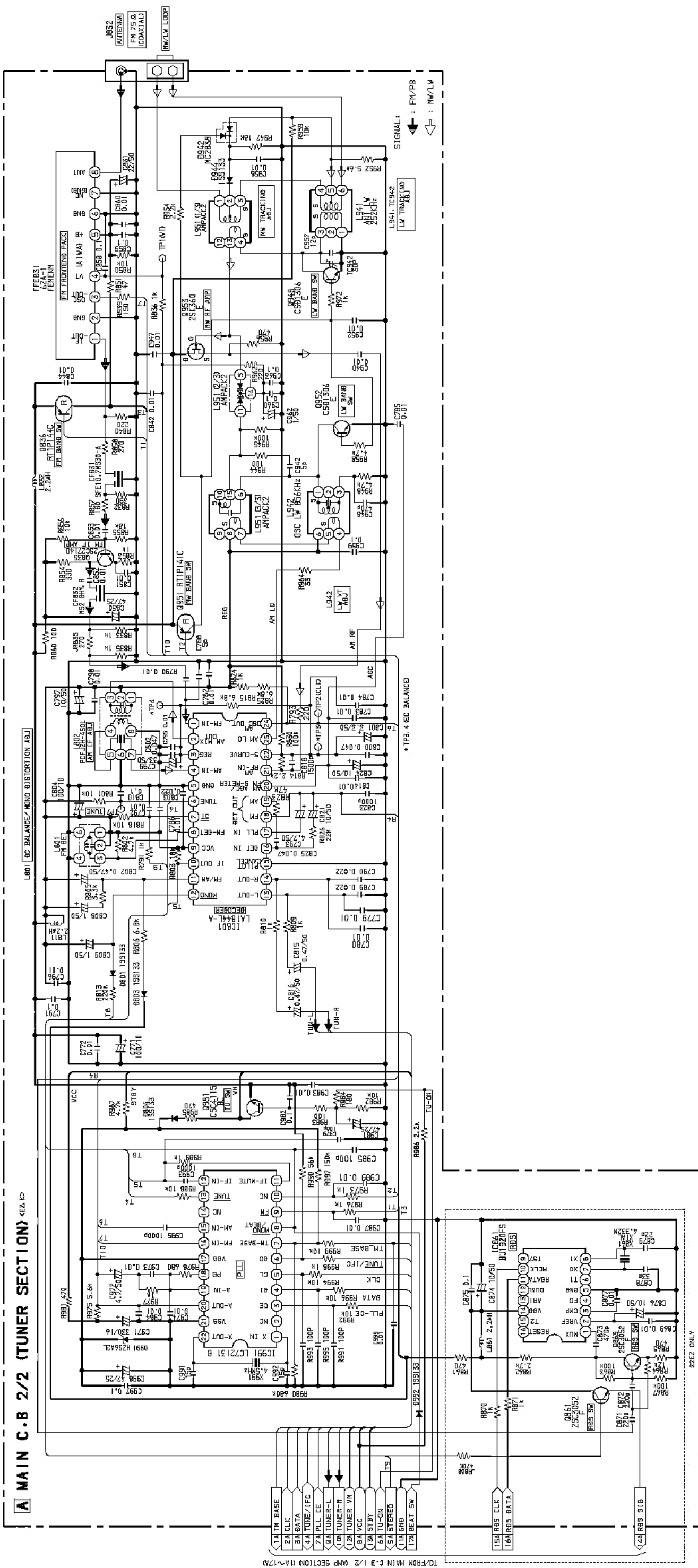

SCHEMATIC DIAGRAM - 4 (MAIN 2/2 : TUNER) <V>

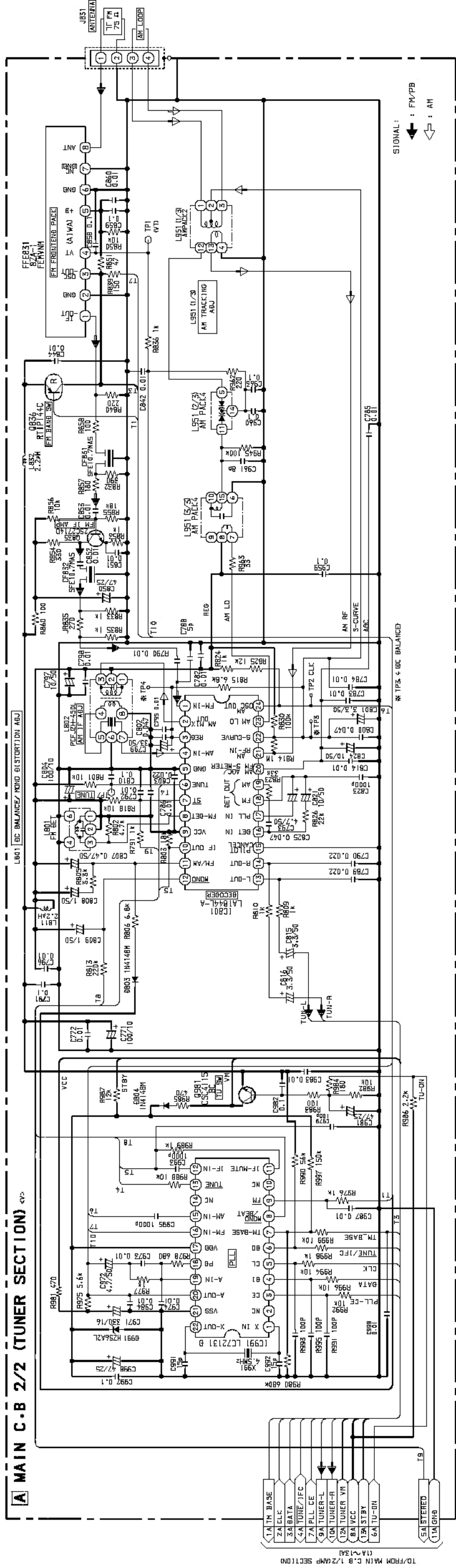

1 2 3 4 5 6 7 8 9 10 11 12 13 14 15 16 17 18 19 20 21 22 23 24 25 26 27 28 29 30 31 32

B FRONT C.B

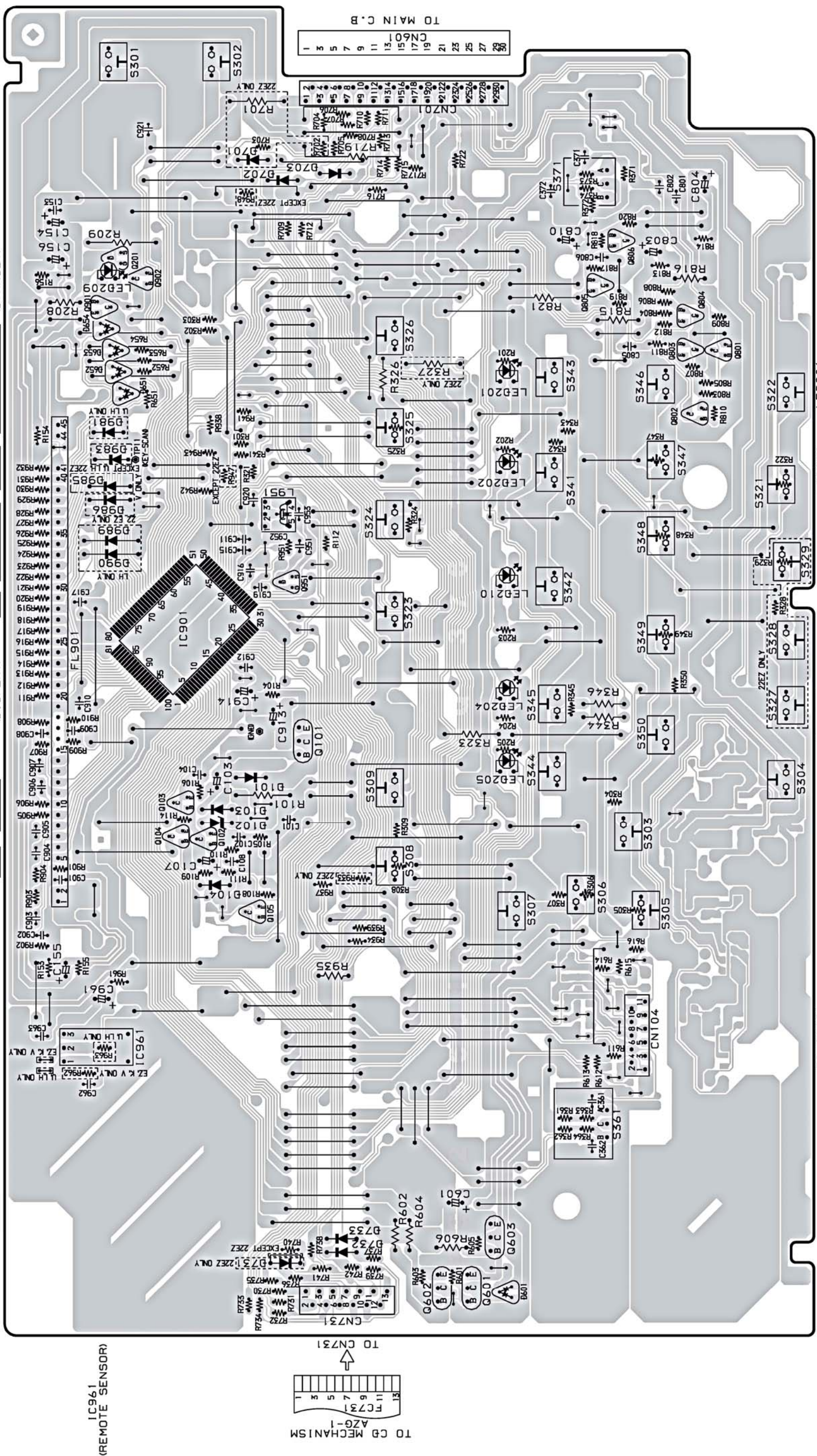

IC961 (REMOTE SENSOR)

TO CD MECHANISM
AZG-1

TO CN731

TO MAIN C.B.
CN201

TO CN104

TO DECK C.B.
CN1

TO DECK C.B.
CN1

TO DECK C.B.
CN1

TO DECK C.B.
CN1

TO DECK C.B.
CN1

TO DECK C.B.
CN1

TO DECK C.B.
CN1

TO DECK C.B.
CN1

TO DECK C.B.
CN1

TO DECK C.B.
CN1

TO DECK C.B.
CN1

TO DECK C.B.
CN1

TO DECK C.B.
CN1

TO DECK C.B.
CN1

TO DECK C.B.
CN1

TO DECK C.B.
CN1

TO DECK C.B.
CN1

TO DECK C.B.
CN1

TO DECK C.B.
CN1

TO DECK C.B.
CN1

TO DECK C.B.
CN1

TO DECK C.B.
CN1

TO DECK C.B.
CN1

TO DECK C.B.
CN1

TO DECK C.B.
CN1

SCHEMATIC DIAGRAM - 5 (FRONT)

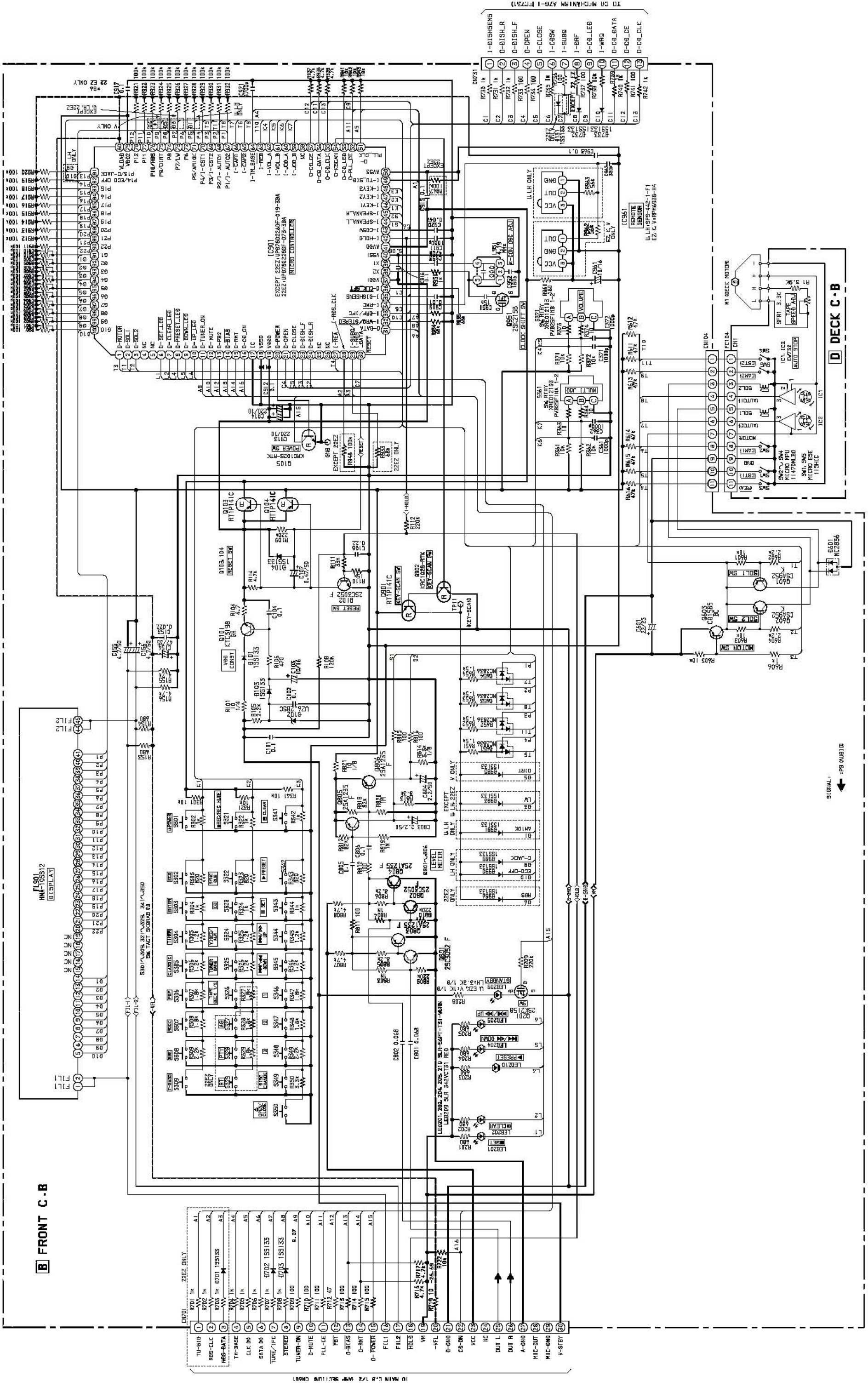

WIRING - 4 (PT) <LH>

15	14	13	12	11	10	9	8	7	6	5	4	3	2	1
----	----	----	----	----	----	---	---	---	---	---	---	---	---	---

A
B
C
D
E
F
G
H
I
J
K
L
M
N
O
P
Q
R
S
T
C

C PT C.B <LH>

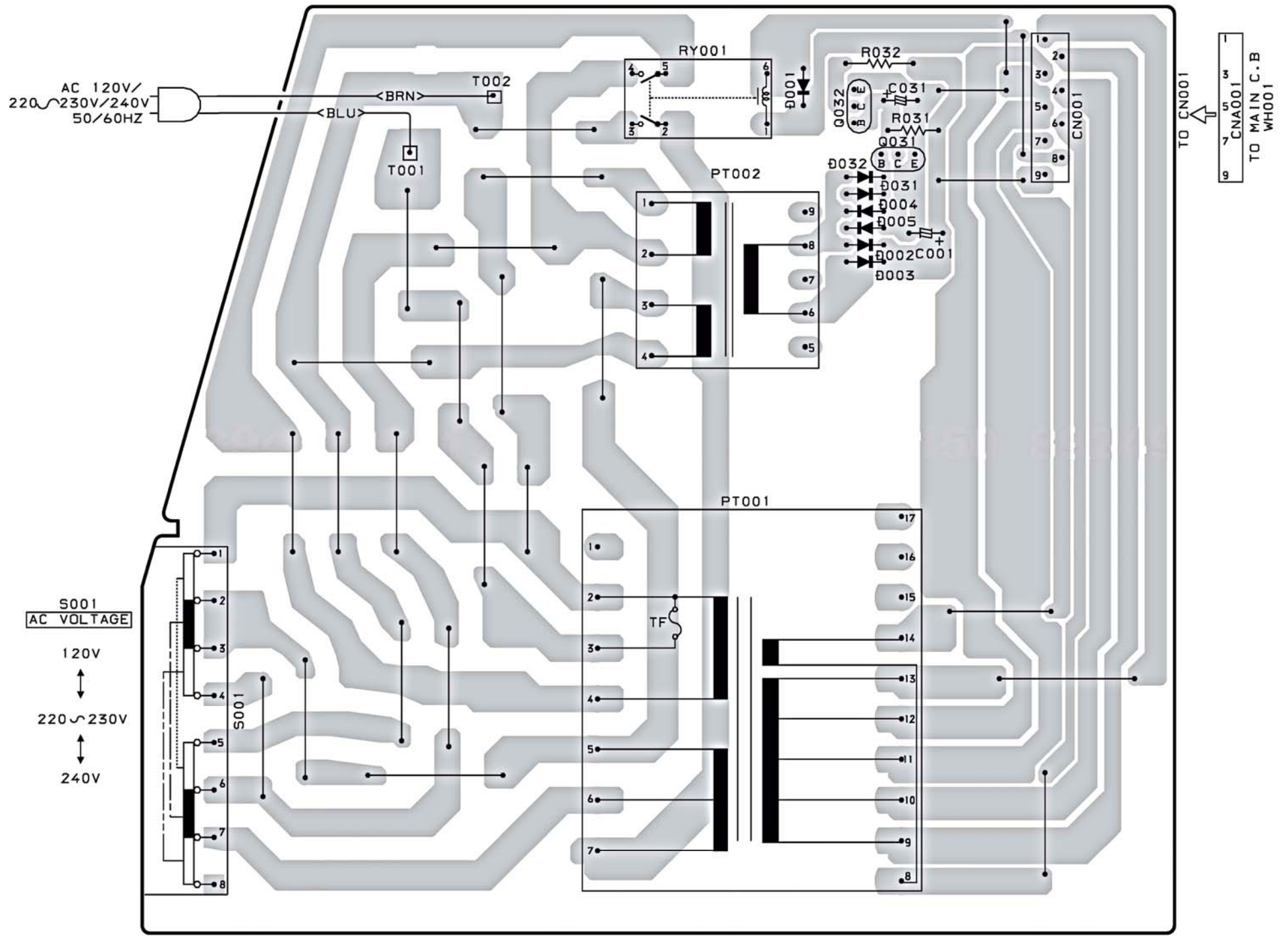

SCHEMATIC DIAGRAM - 6 (PT) <LH>

TO MAIN C.B 1/2 (AMP SECTION) WH001 (CNA1)

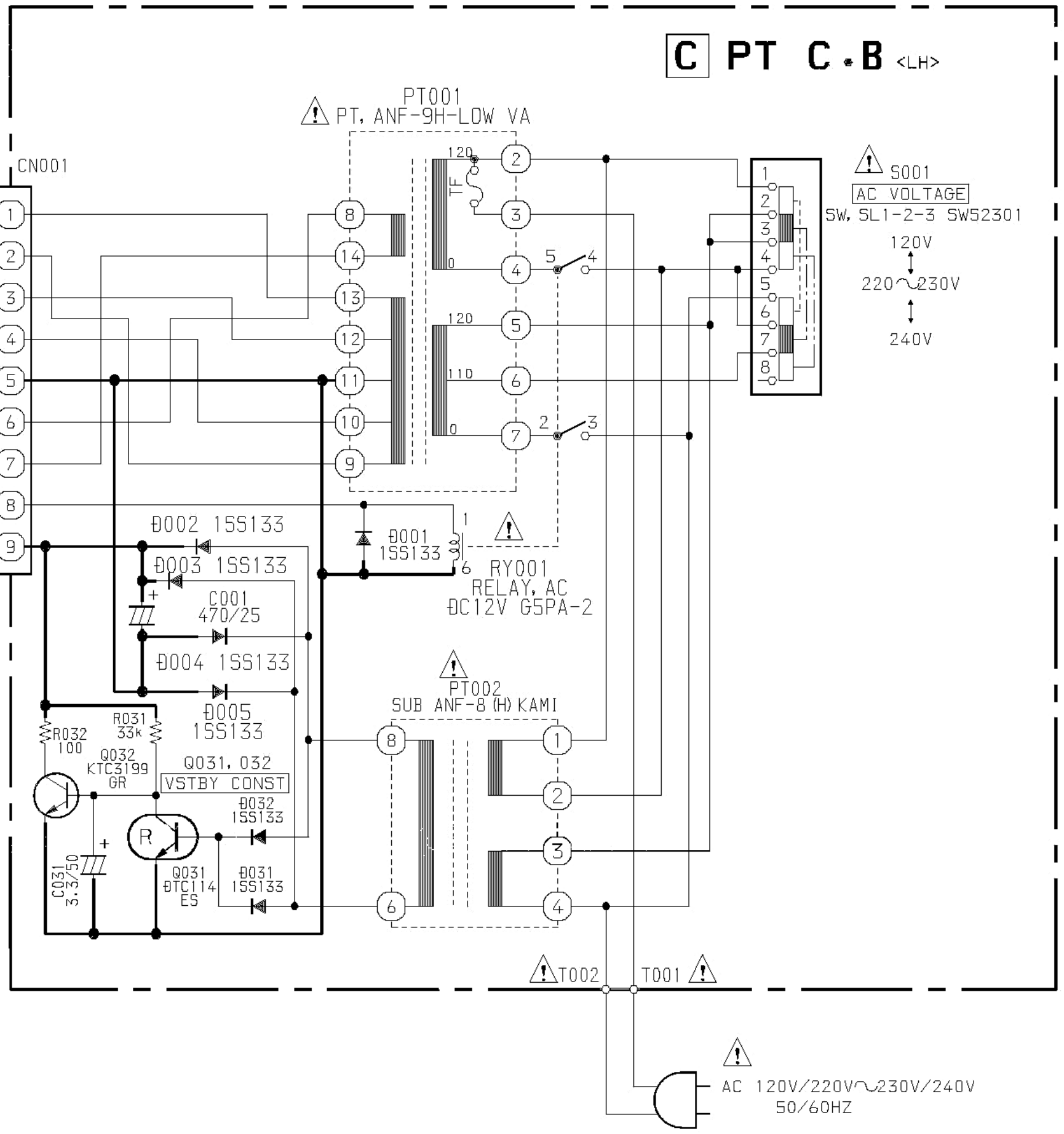

WIRING - 5 (PT) <U, EZ, K, V>

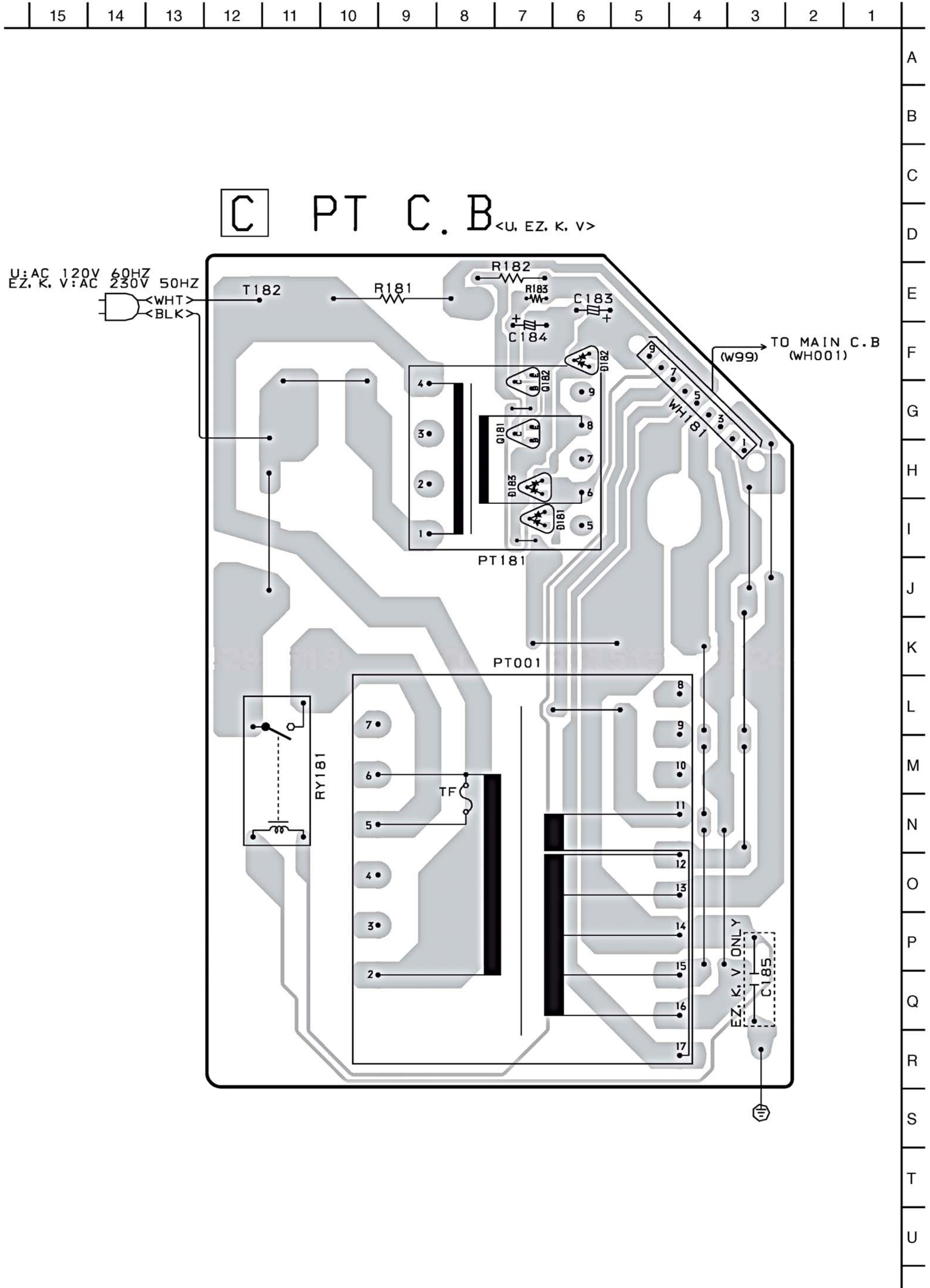

SCHEMATIC DIAGRAM - 7 (PT) <U,EZ,K,V>

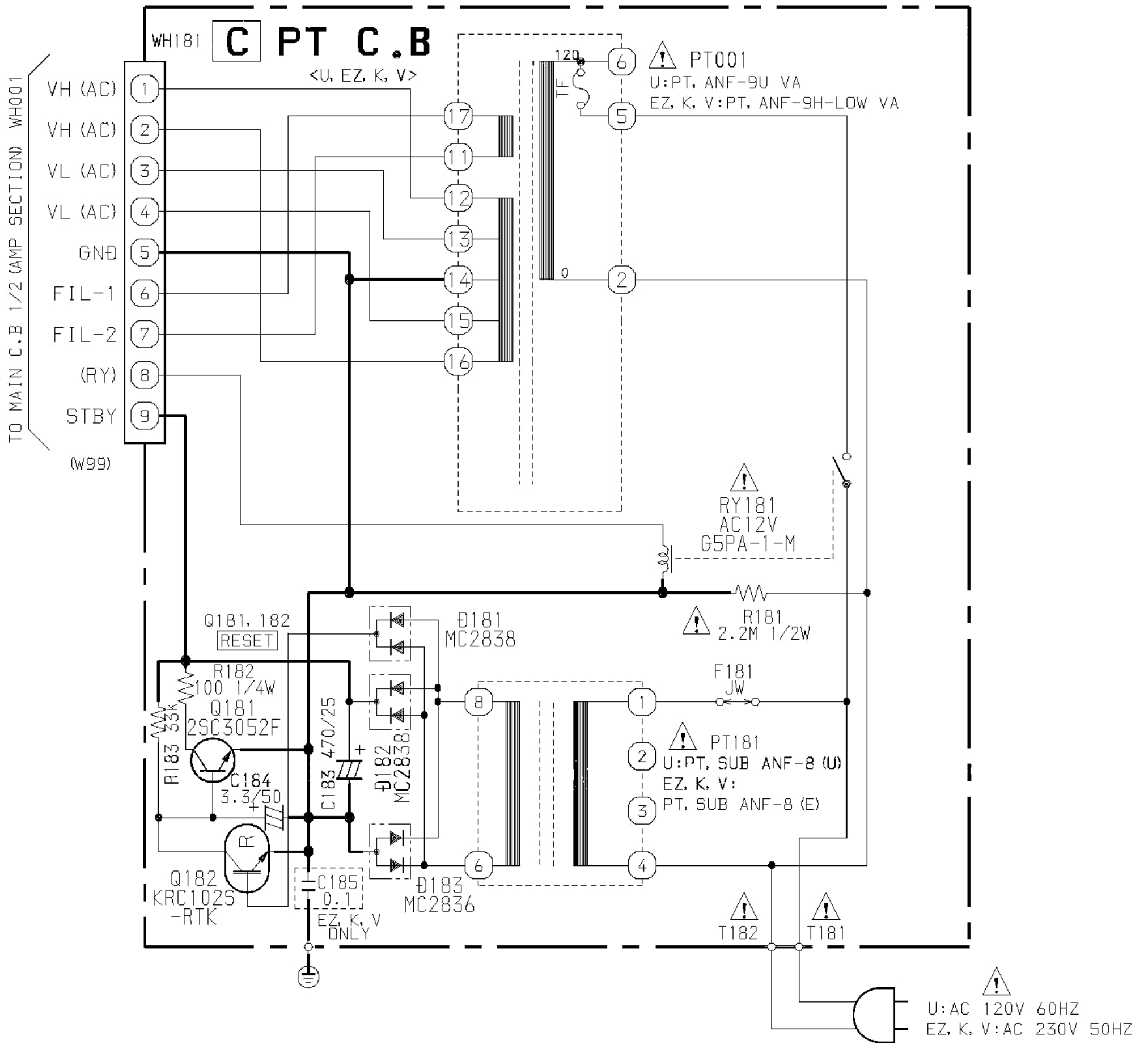

IC BLOCK DIAGRAM

IC, LC72131B-N

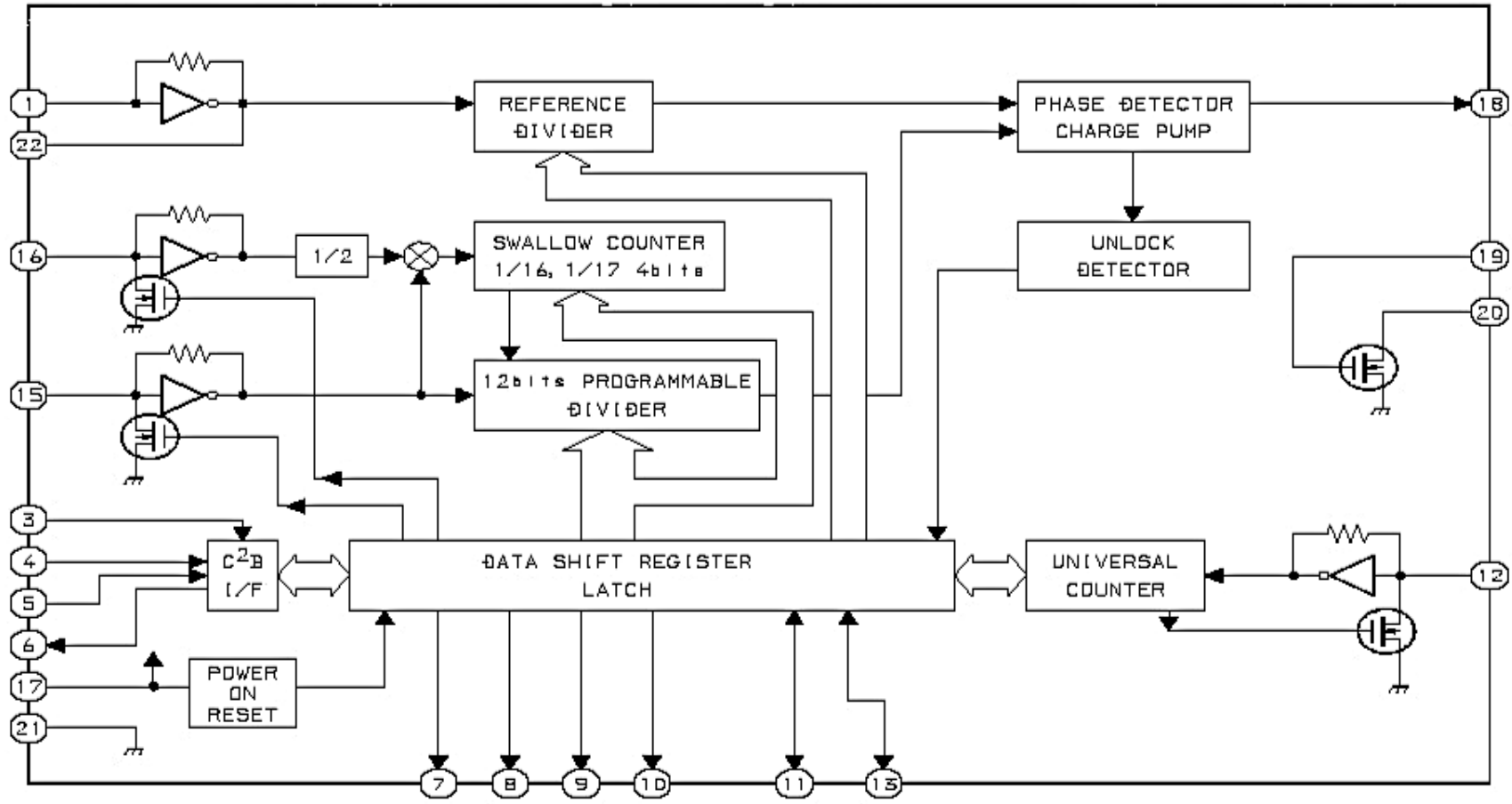

ADJUSTMENT <TUNER / DECK / FRONT>

<TUNER SECTION >

1. Clock Frequency Check
Settings : • Test point : TP2 (CLK)
Method : Set to AM 1710kHz(U,LH), MW 1602kHz(EZ,K), AM 1602kHz(V) and check that the test point is 2160kHz \pm 45Hz(U,LH), 2052kHz \pm 45Hz(EZ,K,V).
2. AM(MW) VT Check
Settings : • Test point : TP1 (VT)
Method : Set to AM 1710kHz(U,LH), MW 1602kHz(EZ,K), AM 1602kHz(V) and check that the test point is less than 8.5V(U,LH), less than 8.0V(EZ,K,V). Then set to AM 530kHz(U,LH), MW 531kHz(EZ,K), AM 531kHz(V) and check that the test point is more than 0.6V.
3. LW VT Adjustment <EZ,K>
Settings : • Test point : TP1 (VT)
• Adjustment location : L942
Method : Set to LW 144kHz and adjust L942 so that the test point becomes 1.3V \pm 0.05V. Then set to LW 290kHz and check that the test point is less than 8.0V.
4. FM VT Check
Settings : • Test point : TP1 (VT)
Method : U,LH,EZ,K:
Set to FM 87.5MHz, 108.0MHz and check that the test point is more than 0.5V (87.5MHz) and less than 8.0V (108.0MHz).
V:
Set to FM 65.0MHz, 108.0MHz and check that the test point is more than 1.0V (65.0MHz) and less than 9.5V (108.0MHz).
5. AM(MW) Tracking Adjustment
Settings : • Test point : TP8(Lch), TP9(Rch)
• Adjustment location : L951(1/3)
Method : Set to AM 1000kHz(U,LH), MW 999kHz(EZ,K), AM 999kHz(V) and adjust L951(1/3) to MAX.
6. LW Tracking Adjustment <EZ,K>
Settings : • Test point : TP8(Lch), TP9(Rch)
• Adjustment location :
L941 144kHz
TC942 290kHz
Method : Set up TC942 to center before adjustment.
Adjust L941 so that the level at 144kHz becomes maximum. Then adjust TC942 so that the level at 290kHz becomes maximum.
7. FM Tracking Check
Settings : • Test point : TP8(Lch), TP9(Rch)
Method : Set to FM 98.0MHz and check that the test point is less than 9dB μ V(U,LH), less than 13dB μ V(EZ,K) and less than 8dB μ V(V).
8. AM IF Adjustment
Settings : • Test point : TP8(Lch), TP9(Rch)
• Adjustment location :
L802 450kHz
9. DC Balance / Mono Distortion Adjustment
Settings : • Test point : TP3, TP4 (DC Balance)
TP8(Lch), TP9(Rch) (Distortion)
• Adjustment location : L801
• Input level : 60dB μ V

Method : Set to FM 98.0MHz and adjust L801 so that the voltage between TP3 and TP4 becomes 0V \pm 300mV.
Next, check that the distortion is less than 1.3%.

<DECK SECTION >

10. Tape Speed Adjustment (DECK 2)
Settings : • Test tape : TTA-100
• Test point : TP8(Lch), TP9(Rch)
• Adjustment location : SFR1
Method : Play back the test tape and adjust SFR1 so that the frequency counter reads 3000Hz \pm 5Hz (FWD) and FWD SPEED \pm 45Hz (REV).
 11. Head Azimuth Adjustment (DECK 1, DECK 2)
Settings : • Test tape : TTA-330
• Test point : TP8(Lch), TP9(Rch)
• Adjustment location : Azimuth adjustment screw
Method : Play back (FWD) the 8kHz signal of the test tape and adjust screw so that the output becomes maximum.
Next, perform on REV PLAY mode.
 12. PB Frequency Response Check (DECK 1, DECK 2)
Settings : • Test tape : TTA-330
• Test point : TP8(Lch), TP9(Rch)
Method : Play back the 315Hz and 8kHz signals of the test tape and check that the output ratio of the 8kHz signal with respect to that of the 315Hz signal is within 5.0dB.
 13. PB Sensitivity Check (DECK 1, DECK 2)
Settings : • Test tape : TTA-200
• Test point : TP8(Lch), TP9(Rch)
Method : Play back the test tape and check that the output level of the test point is 110mV \pm 3.0dB.
 14. REC/PB Frequency Response Adjustment (DECK 2)
Settings : • Test tape : TTA-602
• Test point : TP8(Lch), TP9(Rch)
• Input signal : 1kHz / 8kHz (LINE IN)
• Adjustment location : SFR451 (Lch)
SFR452 (Rch)
Method : Apply a 1kHz signal and REC mode. Then adjust OSC attenuator so that the output level at the TP8, TP9 becomes -20VU (-26dBV). Record and play back the 1kHz and 8kHz signals and adjust SFRs so that the output of the 8kHz signals becomes -1.5dB \pm 0.5dB<U>, 0dB \pm 0.5dB<except U>, with respect to that of the 1kHz signal.
 15. REC/PB Sensitivity Check (DECK 2)
Settings : • Test tape : TTA-602
• Test point : TP8(Lch), TP9(Rch)
• Input signal : 1kHz (LINE IN)
Method : Apply a 1kHz signal and REC mode. Then adjust OSC attenuator so that the output level at TP8, TP9 becomes 0VU (-6dBV). Record and play back the 1kHz signals and check that the output is -1dB \pm 3.5dB.
- ### <FRONT SECTION >
16. μ -CON OSC Adjustment
Settings : • Test point : TP11 (KEY-SCAN), (GND)
• Adjustment location : L951
Method : Connect a frequency counter across TP11 (KEY-SCAN) and GND. Insert AC plug while pressing POWER key and TUNER function key. Then adjust L951 so that the test point becomes 92.470Hz \pm 0.092Hz. To manual reset press POWER key while pressing CLEAR key.

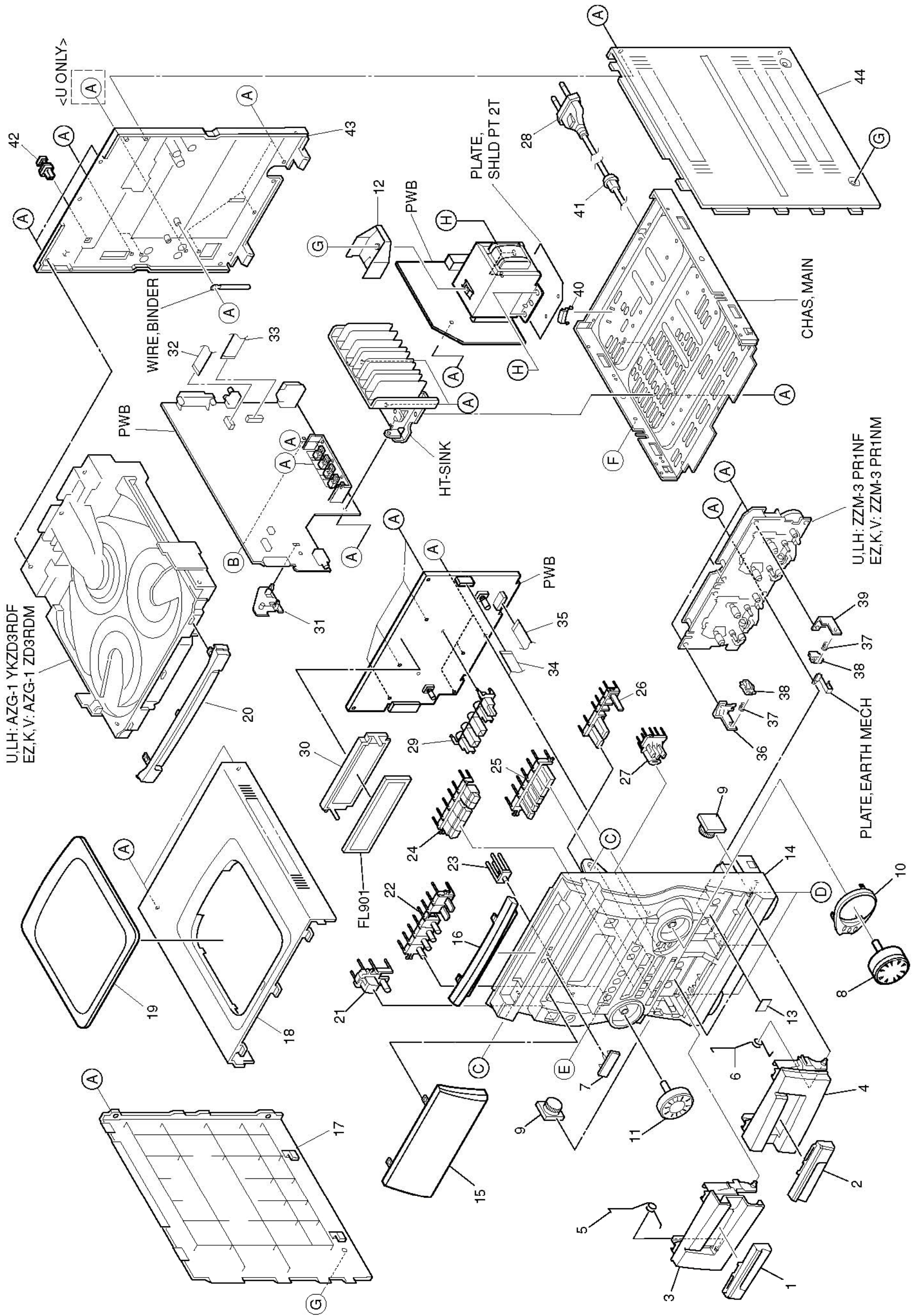

MECHANICAL PARTS LIST 1 / 1

REF. NO.	PART NO.	KANRI NO.	DESCRIPTION	REF. NO.	PART NO.	KANRI NO.	DESCRIPTION
1	8A-NF9-006-010		WINDOW, CASS 1<EXCEPT 27EZ>	25	8A-NF9-020-110		KEY, CD
2	8A-NF9-085-010		WINDOW, CASS 1 B<27EZ>	26	8A-NF9-050-010		KEY, RDS<22EZ>
3	8A-NF9-007-010		WINDOW, CASS 2<EXCEPT 27EZ>	27	8A-NF9-019-010		KEY, SYNC<EXCEPT 22EZ>
4	8A-NF9-086-010		WINDOW, CASS 2 B<27EZ>	28	8A-NF9-026-110		KEY, ENTER
5	8A-NF9-003-010		BOX, CASS 1<EXCEPT 27EZ>	28	87-A80-157-010		AC COORD ASSY, E BLK CC<EXCEPT U>
6	8A-NF9-082-010		BOX, CASS 1 B<27EZ>	28	87-A80-110-010		AC COORD ASSY, U SPT-2M<U>
7	8A-NF9-004-010		BOX, CASS 2<EXCEPT 27EZ>	29	8A-NF9-201-010		GUIDE, OPE 1 WAY
8	8A-NF9-083-010		BOX, CASS 2 B<27EZ>	30	82-NF7-210-110		GUIDE, FL (*)
9	8A-NF8-209-010		SPR-T, EJECT 1	31	8A-NF8-206-010		HDR, PWB M
10	8A-NF8-207-010		SPR-T, EJECT 2	32	88-906-251-110		FF-CABLE, 6P 1.25 (RVS-FACE)
11	87-CE3-023-010		BADGE, AIWA 30N SILV	33	8A-NF9-609-010		FF-CABLE, 9P 2.5 480MM<EXCEPT LH>
12	8A-NF9-018-010		KNOB, RTRY JOG	34	88-913-301-110		FF-CABLE, 13P-1.25
13	8A-NF8-209-010		OIL-DMPR, 120	35	88-911-101-110		FF-CABLE, 11P 1.25
14	8A-NF9-017-010		PANEL, JOG	36	87-NF4-216-010		HDR, LOCK 1
15	8A-NF9-016-010		KNOB, RTRY VOL	37	86-NF9-224-010		SPT-C, LOCK
16	8A-NF9-211-010		HDR, PWB PT HI	38	82-NF5-229-010		PLATE, LOCK
17	81-532-080-010		LABEL, CASS. COMPT	39	87-NF4-217-110		HDR, LOCK 2
18	8A-NF9-049-010		CABI, FR EZ R<22EZ>	40	87-NF4-221-010		HDR, CABLE
19	8A-NF9-081-010		CABI, FR EZB<27EZ	41	87-085-185-010		BUSHING, AC COORD (E)<EXCEPT U>
20	8A-NF9-001-010		CABI, FR U<EXCEPT 22EZ, 27EZ>	41	87-A91-422-010		BUSHING, AC COORD(U)<U>
21	8A-NF9-103-010		WINDOW, DISP EZ NDRI<NDRI>	42	84-EGL-245-210		CAP, OPTICAL
22	8A-NF9-044-010		WINDOW, DISP EZ RDS<22EZ>	43	8A-NF9-031-110		CABI, REAR EZSE R<EZ>
23	8A-NF9-084-010		WINDOW, DISP EZB E27<27EZ>	43	8A-NF9-063-010		CABI, REAR KSM<K>
24	8A-NF9-052-010		WINDOW, DISP LH<LH, V, 20EZ, K>	43	8A-NF9-056-110		CABI, REAR LHSFD<LH>
25	8A-NF9-005-010		WINDOW, DISP U<U>	43	8A-NF9-057-110		CABI, REAR USFD<U>
26	8A-NF9-039-010		WINDOW, CD<EXCEPT 27EZ>	43	8A-NF9-036-110		CABI, REAR VISM<V>
27	8A-NF9-089-010		WINDOW, CD B<27EZ>	44	8A-NF8-008-010		PANEL, RIGHT V-2<EXCEPT 27EZ>
28	8A-NF8-007-010		PANEL, LEFT V-2<EXCEPT 27EZ>	44	8A-NF9-093-010		PANEL, RIGHT V-2 B<27EZ>
29	8A-NF9-092-010		PANEL, LEFT V-2 B<27EZ>	A	87-067-703-010		TAPPING SCREW, BVT2+3-10
30	8A-NF8-005-010		PANEL, TOP<EXCEPT 27EZ>	B	87-NF4-224-010		S-SCREW, IT3B+3-8 CU
31	8A-NF9-090-010		PANEL, TOP B<27EZ>	C	87-721-097-410		QT2+3-12 GLD
32	8A-NF8-006-010		WINDOW, TOP<EXCEPT 27EZ>	D	87-067-689-010		TAPPING SCREW, BVT+3-8
33	8A-NF9-091-010		WINDOW, TOP B<27EZ>	E	87-723-096-410		QT2+3-10W/O SLOT BL
34	8A-NF9-014-010		PANEL, TRAY<EXCEPT 27EZ>	F	87-721-096-410		QT2+3-10 GLD
35	8A-NF9-088-010		PANEL, TRAY B<27EZ>	G	87-067-641-010		UTT2+3-8 (W/O SLOT) BL
36	8A-NF9-008-010		KEY, POWER<EXCEPT 27EZ>	H	87-078-200-010		S-SCREW, ITC+4-8 R
37	8A-NF9-087-010		KEY, POWER B<27EZ>				
38	8A-NF9-009-010		KEY, FUN				
39	8A-NF9-022-010		REFLECTOR, ECO				
40	8A-NF9-010-110		KEY, ASSY OPE 1 WAY				

COLOR NAME TABLE

Basic color symbol	Color	Basic color symbol	Color	Basic color symbol	Color
B	Black	C	Cream	D	Orange
G	Green	H	Gray	L	Blue
LT	Transparent Blue	N	Gold	P	Pink
R	Red	S	Silver	ST	Titan Silver
T	Brown	V	Violet	W	White
WT	Transparent White	Y	Yellow	YT	Transparent Yellow
LM	Metallic Blue	LL	Light Blue	GT	Transparent Green
LD	Dark Blue	DT	Transparent Orange	GM	Metallic Green
YM	Metallic Yellow	DM	Metallic Orange	PT	Transparent Pink
LA	Aqua Blue	GL	Light Green		

TAPE MECHANISM EXPLODED VIEW 1 / 1

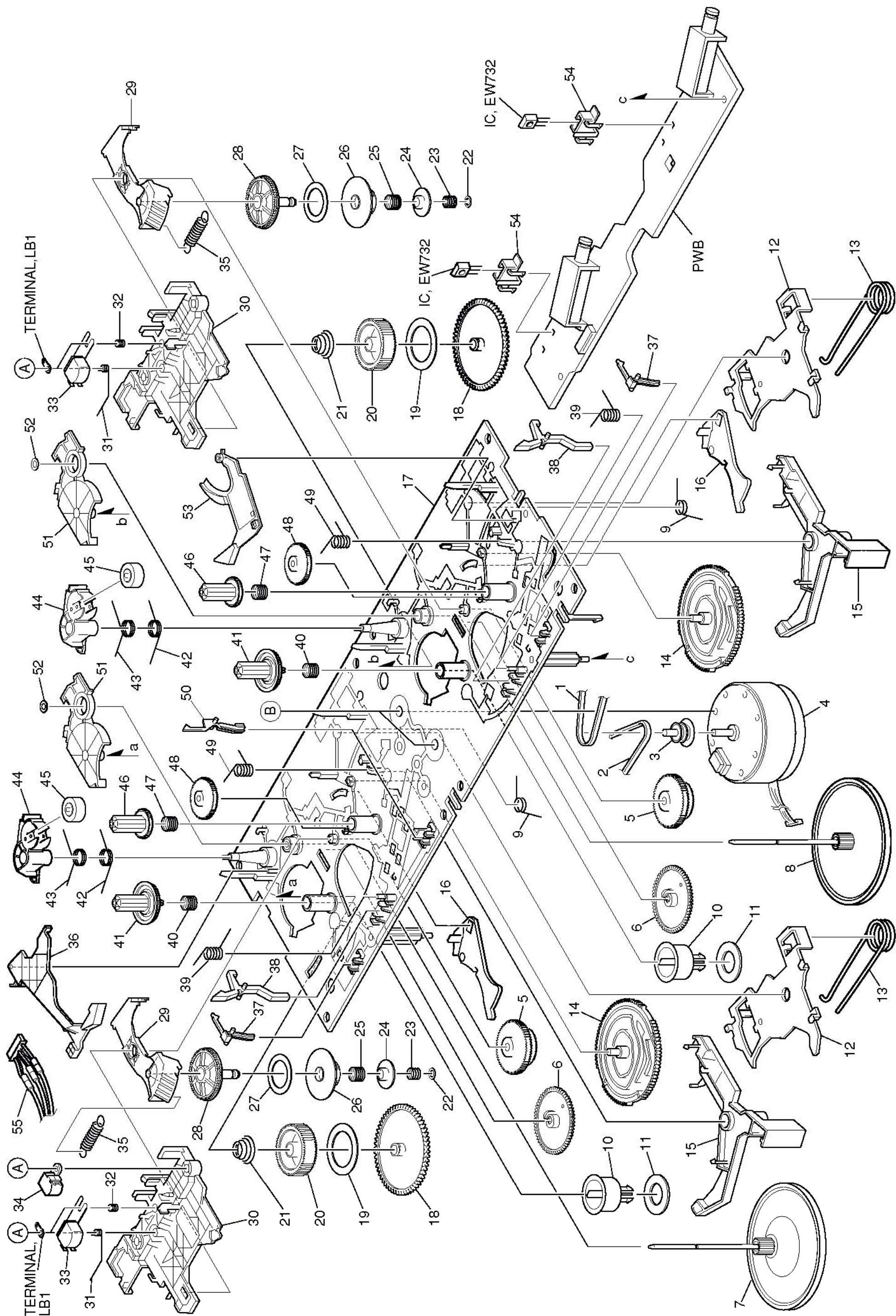

TAPE MECHANISM PARTS LIST 1 / 1

REF. NO.	PART NO.	KANRI NO.	DESCRIPTION	REF. NO.	PART NO.	KANRI NO.	DESCRIPTION
1	8Z-ZM3-227-010		BELT, MAIN M3	31	8Z-ZM3-233-010		SPR-T, BRG M3
2	8Z-ZM3-235-010		BELT, MAIN L	32	84-ZM2-227-310		SPR-C, AZIMUTH
3	8Z-ZM1-235-010		PULLEY, MOT	33	87-A90-403-110		HEAD, RPH MS15R
4	87-045-347-010		MOT, SHU2L 70	34	87-A90-404-010		HEAD, EH LE15B
5	8Z-ZM1-232-010		GEAR, IDL FF/REW	35	8Z-ZM3-239-010		SPR-E, FR
6	8Z-ZM3-244-010		GEAR, CAM TD20	36	8Z-ZM3-211-010		LEVER, EJECT R
7	8Z-ZM3-256-010		FLY-WHL ASSY, M3 R	37	8Z-ZM3-225-010		LEVER, STOP
8	8Z-ZM3-255-010		FLY-WHL ASSY, M3 L	38	8Z-ZM3-221-010		LEVER, CAS
9	8Z-ZM3-231-010		SPR-T, TRIG	39	8Z-ZM3-234-010		SPR-T, LVR CAS
10	8Z-ZM3-213-010		CLR, MG	40	8Z-ZM3-223-010		SPR-C, REEL R M3
11	8Z-ZM3-616-010		RING MAGNET 4	41	8Z-ZM1-225-110		GEAR, REEL R
12	8Z-ZM3-243-010		LEVER ASSY, HD UP	42	8Z-ZM3-240-010		SPR-T, T-UP M3
13	8Z-ZM3-238-010		SPR-T, HD UP	43	8Z-ZM3-237-010		SPR-T, PINCH M3
14	8Z-ZM3-219-010		GEAR, CAM M3	44	8Z-ZM3-215-010		LEVER, PINCH M3
15	8Z-ZM3-206-010		LEVER, TRIG	45	8Z-ZM1-261-110		ROLLER ASSY, PINCH
16	8Z-ZM3-209-010		LEVER, CAM FR	46	8Z-ZM1-226-010		GEAR, REEL L
17	8Z-ZM3-203-010		CHAS ASSY, M3	47	8Z-ZM3-222-010		SPR-C, REEL L M3
18	8Z-ZM1-228-010		GEAR, SLIP T-UP B	48	8Z-ZM3-251-010		GEAR, IDL REW M3
19	8Z-ZM1-265-010		FELT, T-UP	49	8Z-ZM3-236-010		SPR-T, PLAY M3
20	8Z-ZM1-227-010		GEAR, SLIP T-UP A	50	8Z-ZM1-240-110		LVR, REC (*)
21	8Z-ZM1-251-110		SPR-C, T-UP SLIP	51	8Z-ZM3-216-010		LEVER, T-UP M3
22	8Z-ZM1-275-010		W-L, 1, 47-4-0.25	52	87-B10-301-010		W-L, 1.63-3.2-05 SLIT
23	8Z-ZM1-257-010		SPR-C, F/R	53	8Z-ZM3-212-010		LEVER, EJECT L
24	8Z-ZM1-236-010		CLR, SLIP FF/REW	54	8Z-ZM3-214-010		HLDR, IC
25	8Z-ZM3-226-010		SPR-C, FR M3	55	86-ZM3-605-110		CONN ASSY, 8P -RPB
26	8Z-ZM3-250-010		GEAR, SLIP F/R A M3	A	84-ZM2-242-010		S-SCREW, AZ1-2-6.4
27	8Z-ZM1-269-010		FELT, FF/REW 2	B	8Z-ZM2-220-110		V+2.6 ZZM-2
28	8Z-ZM1-238-110		GEAR, SLIP FF/REW B 2				
29	8Z-ZM3-220-010		LEVER, FR M3				
30	8Z-ZM3-205-010		LEVER, PLAY M3				

SPEAKER PARTS LIST
 SX-NAJ22(YUSL,YJSC),
 SX-NSZ20 (YBC9,YBY1,YBY2,YSC,YSL,YSC9,YSY1,YSY2),
 SX-NSZ22 (YLSL,YLSC,YJSC,YJSC9,YSC,YSC9,YSY1,YSY2)

REF. NO.	PART NO.	KANRI NO.	DESCRIPTION
1	8A-NSK-001-010		PANEL,FR<EXCEPT YBC9,YBY1,YBY2>
2	8A-NSK-003-010		GRILLE,FRAME ASSY<EXCEPT 22YSC>
3	8A-NSK-031-010		GRILLE,FRAME ASSY<22YSC>
4	8A-NSK-007-010		PROTECTOR,TWA
4	8A-NSK-602-010		SPKR,W 140<EXCEPT 20YSC,22YJSC,22YLSC,22YUSC,22YSC9>
4	8A-NSK-608-010		SPKR,W 130<20YSC,22YJSC,22YLSC,22YSC,22YSC9>
4	8A-NSK-608-010		SPKR,W 130<22YUSC>
5	88-NS5-605-010		SPKR,T 60<EXCEPT 20YSC,22YJSC,22YLSC,22YUSC,22YSC,22YSC9>
5	8A-NSK-604-010		SPKR,TW 60<20YSC,22YJSC,22YLSC,22YSC,22YSC9>
5	8A-NSK-610-010		SPKR,TW 60<22YUSC>
6	87-NSH-612-010		SPKR,CERAMIC ASSY
7	87-NS7-611-010		CORD,SPKR

ACCESSORIES / PACKAGE LIST

REF. NO.	PART NO.	KANRI NO.	DESCRIPTION
1	8A-NF9-903-110		IB,U(ESF)M<U>
1	8A-NF9-902-110		IB,LH(ESP)M<LH>
1	8A-NF9-926-010		IB,EZ(9L)M<20EZ,27EZ,NDR1>
1	8A-NF9-927-010		IB,EZ(9L)M S222(RDS)<22EZ>
1	8A-NF9-905-010		IB,K(E)E<K>
1	8A-NF9-907-210		IB,V(ER)M<V>
2	87-043-115-010		FEEDER-ANT FM<U,LH,V>
2	87-A90-118-010		ANT,WIRE FM(Z)<EZ,K>
3	87-006-268-010		ANT LOOP AM<U,LH>
3	87-006-225-010		AM,LOOP ANT NC2<EZ,K,V>
4	82-NF9-701-210		RC UNIT,ZAS02<EXCEPT 27EZ>
4	82-NF9-703-110		RC UNIT,ZAS17<27EZ>
5	87-A91-017-010		PLUG CONVERSION, JT-0476<LH>

アイワ株式会社 〒110-8710 東京都台東区池之端1-2-11 ☎03(3827)3111 (代表)
AIWA CO.,LTD. 2-11, IKENOHATA 1-CHOME, TAITO-KU, TOKYO 110, JAPAN TEL:03 (3827) 3111